



NC DEPARTMENT OF HEALTH AND HUMAN SERVICES

ROY COOPER • Governor
MANDY COHEN, MD, MPH • Secretary
MARK PAYNE • Director, Division of Health Service Regulation

VIA EMAIL ONLY

March 10, 2021

Robert A. Hamill
RHamill@hallrender.com

Exempt from Review – Replacement Equipment

Record #: 3501
Date of Request: February 19, 2021
Facility Name: Sampson Radiation Oncology
FID #: 030361
Business Name: North Carolina Radiation Management Services, LLC
Business #: 2124
Project Description: Replace existing linear accelerator
County: Sampson

Dear Mr. Hamill:

The Healthcare Planning and Certificate of Need Section, Division of Health Service Regulation (Agency), determined that the above referenced project is exempt from certificate of need review in accordance with G.S. 131E-184(7). Therefore, you may proceed to acquire without a certificate of need the Elekta Versa HD linear accelerator (model number to be determined) to replace the existing 1975 21EX Varian linear accelerator. This determination is based on your representations that the existing unit will be sold or otherwise disposed of and will not be used again in the State without first obtaining a certificate of need if one is required.

It should be noted that the Agency's position is based solely on the facts represented by you and that any change in facts as represented would require further consideration by this office and a separate determination. If you have any questions concerning this matter, please feel free to contact this office.

Sincerely,

[Handwritten signature of Tanya M. Saporito]

Tanya M. Saporito
Project Analyst

[Handwritten signature of Lisa Pittman]

Lisa Pittman
Assistant Chief, Certificate of Need

cc: Radiation Protection Section, DHSR
Construction Section, DHSR

NC DEPARTMENT OF HEALTH AND HUMAN SERVICES • DIVISION OF HEALTH SERVICE REGULATION
HEALTHCARE PLANNING AND CERTIFICATE OF NEED SECTION

LOCATION: 809 Ruggles Drive, Edgerton Building, Raleigh, NC 27603
MAILING ADDRESS: 809 Ruggles Drive, 2704 Mail Service Center, Raleigh, NC 27699-2704
https://info.ncdhhs.gov/dhsr/ • TEL: 919-855-3873



Hall, Render, Killian, Heath & Lyman, LLP
Perimeter Three
3015 Carrington Mill Blvd.
Suite 450
Morrisville, North Carolina 27560

Robert A. Hamill
(919) 447-4970
rhamill@hallrender.com

February 19, 2021

VIA EMAIL

Martha Frisone
Chief
North Carolina Division of Health Service Regulation
Healthcare Planning and Certificate of Need Section
809 Ruggles Drive
Raleigh, NC 27603
Martha.Frisone@dhhs.nc.gov

RE: Replacement of Linear Accelerator at 210 Beaman Street, Clinton, NC 28326

Dear Ms. Frisone:

We represent North Carolina Radiation Therapy Management Services, LLC (“**NCRTMS**”). We are writing to inform the North Carolina Department of Health and Human Services, Division of Health Service Regulation, Health Planning and Certificate of Need Section (“**CON Section**”) of NCRTMS’ intention to replace the linear accelerator that is currently in operation at 210 Beaman Street, Clinton, North Carolina 28326 (“**Existing Equipment**”). For the reasons explained below, NCRTMS’ replacement of the Existing Equipment is exempt from certificate of need (“**CON**”) review pursuant to N.C. Gen. Stat. § 131E-184(a)(7).

1. **Description of Equipment.**

The Existing Equipment is a Varian Clinac 21EX. A description of the Existing Equipment’s features and capabilities is attached hereto as Exhibit A. The Existing Equipment was acquired by NCRTMS as refurbished equipment in 2011. The Existing Equipment has been in operation at Sampson Radiation Oncology, a division of Radiation Therapy Associates of Western North Carolina, since that time, and is used to provide radiation therapy for the treatment of cancer. Upon replacement, the Existing Equipment will be moved out of state and disposed of.

NCRTMS intends to replace the Existing Equipment with a new Elekta Versa HD linear accelerator acquired from Elekta (“**Replacement Equipment**”). The Replacement Equipment will be used to provide the same radiation treatment to cancer patients as the Existing

Equipment. The Replacement Equipment will have the same technology as the Existing Equipment, will be functionally similar to the Existing Equipment, and will be used to provide the same cancer treatments to patients. A description of the Replacement Equipment's features and capabilities is attached hereto as Exhibit B. The acquisition of the Replacement Equipment will not result in more than a 10% increase in patient charges or per-procedure operating expenses within the first 12 months following acquisition. NCRTMS' total cost to acquire the Replacement Equipment is estimated to be approximately \$1,958,550.00. A summary of the costs to acquire and install the replacement equipment is attached hereto as Exhibit C. Documentation supporting those costs is attached hereto as Exhibit D.

2. **Overview of Applicable Law.**

"Replacement equipment" is exempt from CON review. N.C. Gen. Stat. § 131E-184(a)(7). "Replacement equipment" is equipment that costs less than \$2,000,000 and is purchased for the sole purpose of replacing comparable medical equipment currently in use which will be sold or otherwise disposed of when replaced. N.C. Gen. Stat. § 131E-176(22a). The cost of the equipment, studies, surveys, designs, plans, working drawings, specifications, construction, installation, and other activities essential to acquiring and making the equipment operational shall be included when calculating the total cost of replacement equipment. *Id.*

Replacement equipment is comparable to the equipment being replaced if: (i) it has the same technology as the existing equipment, although it may possess expanded capabilities due to technological advancements; (ii) it is functionally similar and used for the same diagnostic or treatment purposes and is not used to provide a new health service; and (iii) the acquisition of the equipment does not result in more than a 10% increase in patient charges or per-procedure operating expenses within the first 12 months after replacement. 10a N.C.A.C. 14c. 0303(d).

Replacement equipment is not comparable to the equipment being replaced if, among other reasons: (i) the replacement equipment is new or reconditioned, the existing equipment was purchased second-hand, and the replacement equipment is purchased less than three years after the acquisition of the existing equipment; (ii) the replacement equipment is new, the existing equipment was reconditioned when purchased, and the replacement equipment is purchased less than three years after the acquisition of the existing equipment; or (iii) the replacement equipment is capable of performing procedures that could result in the provision of a new health service or type of procedure that has not been provided with the existing equipment. *Id.* at (e)(1)-(3).

3. **Analysis.**

The Replacement Equipment constitutes "replacement equipment", as defined under Section 131E- 184(a)(7), and is therefore exempt from CON review for the following reasons:

- a. The total cost of the Replacement Equipment is less than \$2,000,000;
- b. The Existing Equipment will be removed from the state and disposed of;

- c. The Replacement Equipment has the same technology as the Existing Equipment;
- d. The Replacement Equipment is functionally similar to the Existing Equipment, will be used for the same treatment purposes, and will not be used to provide a new health service;
- e. The acquisition of the Replacement Equipment will not result in a 10% increase in patient charges or per-procedure operating expenses within the first 12 months; and
- f. While the Existing Equipment was reconditioned when purchased and the Replacement Equipment is new, the Replacement Equipment is being purchased more than three years after the acquisition of the Existing Equipment, and the Replacement Equipment is not capable of performing procedures that could result in the provision of a new health service or type of procedure that has not been provided with the Existing Equipment.

On behalf of NCRTMS, we respectfully request that the CON Section provide written confirmation that NCRTMS' replacement of the Existing Equipment with the Replacement Equipment, as described herein, is exempt from CON review pursuant to N.C. Gen. Stat. § 131E-184(a)(7).

Please do not hesitate to contact me if you have any questions or require additional information. Thank you for your review and consideration of this matter.

Sincerely,

HALL, RENDER, KILLIAN, HEATH & LYMAN, LLP



Robert A. Hamill

Exhibit A
Existing Equipment

[See Attached]

VARIAN

medical systems



INSTALLATION DATA PACKAGE

Section One

*General Information and Clinac iX, Trilogy,
2100C/D, 2300C/D, 21EX, 23EX, Novalis Tx
Equipment Information*

"Clinac" is a trade name for Varian medical linear accelerators.

*English Version
August 2009*

From: Planning Department

Subject: Updates from Section One –September 2008 to August 2009 IDP Release

Overview of August 2009 - major change – revise Shielding Tables and Interconnection Wiring Diagram . RJB wiring diagram from the September 2008 Installation Data Package should be reviewed for the August 2009 RJB changes. Contact Varian Planning for assistance with your project review.

Section One – HE Clinac includes iX, Trilogy, Novalis TX

- pg. 1.21.0 revise shielding tables
- pg. 1.23.0 revise detail A, relocate overhead primary barrier (bump) outside of the treatment vault
- pg. 1.25.0 delete detail B
- pg. 1.26.0 delete detail A
- pg. 1.27.0 revise detail A & B, swap OBI and 4DITC names
- pg. 1.30.0 revise casework, less Block Tray storage
- pg. 1.36.0 swap detail A & B – Side Cable Access Plan as “Standard”
- pg. 1.37.1 revise keynote 64.141
- pg. 1.39.0 revise wiring diagram
- pg. 1.39.2 add keynotes 60.547, 60.650; revise keynotes 61.042, 63.054, 63.065, 63.070, 63.294
- pg. 1.39.3 delete keynotes 68.052, 68.055; revise keynotes 63.493, 63.526, 65.142, 69.047, 69.048
- pg. 1.41.1 update item 022 dimension – increase depth to 26 inches
- pg. 1.43.1 add line item 24 - Group C

pg. 1.37.1 – Cable Access Diagram – revise keynotes 64.141

keynote 64.141

Provide two 2"(50) conduits between the Relay Junction Box (RJB) and the Modulator pull box. The maximum conduit length from the RJB to the Modulator cannot exceed 45'-0" (13,716).

pg. 1.39.2 – Interconnection Wiring Diagram – add keynotes 60.547, 60.650; revise keynotes 61.042, 63.054, 63.065, 63.070, 63.294

keynote 60.547

Provide 120 Vac (typical 60Hz) or 240 Vac (typical 50Hz) 20 amp maximum, for the treatment room Lasers. Route wiring to the Relay Junction Box.

keynote 60.650

Provide 120 Vac (typical 60Hz) or 240 Vac (typical 50Hz) 20 amps maximum, power for the Warning Lights. Route wiring to the Relay Junction Box.

keynote 61.042

The power to lasers is typically supplied by a grounded power receptacle at each laser location. A 3'-0"(900) power cord is provided with each laser. The receptacles are controlled through the Relay Junction Box as defined by the Interconnection Wiring Diagram. Route wiring to the Relay Junction Box.

keynote 63.054

Connections for three Clinac warning lights, usually red colored, incandescent (no fluorescent lighting) are provided. Locate over/near the door, on the outside of the treatment room. They may be required to blink when the x-ray is on. Verify local requirements with regional regulatory agencies.

- > "BEAM - ON" - warning light
- > "BEAM OFF" - warning light
- > "READY" - warning light

The maximum incandescent lamp load is 60 watts per warning light. If a greater load is required, use these circuits to control a larger relay. Route Warning Light wiring to the Relay Junction Box.

pg. 1.39.2 – Interconnection Wiring Diagram – continued

keynote 63.065

The second door interlock switches are shown for paired entry doors. Route interlock switches wiring to the Relay Junction Box.

keynote 63.070

Connections for two On Board Imager (OBI) warning lights, usually red colored, incandescent (no fluorescent lighting) are provided. Locate over the door, on the outside of the treatment room. They may be required to blink when the x-ray is on. Verify local requirements with regional regulatory agencies.

> "X-RAY ON" - OBI warning light

> "GENERATOR ON" - OBI warning light

Route Warning Light wiring to the Relay Junction Box.

keynote 63.294

Treatment Room safety door interlock switches are required for all installations. Provide for both 12 Vdc and 120/220 Vac door interlocks. They are normally open type switches and are used to ensure the room doors are closed during Clinac operation. Verify with the door manufacturer the type of switches supplied with the door or provide compatible type. Route interlock switches wiring to the Relay Junction Box.

pg. 1.39.3 – Interconnection Wiring Diagram - revise keynotes 63.493, 63.526, 65.142, 69.047, 69.048

keynote 63.493

A separate neutron door interlock switch can be accommodated in the door interlock circuit. Route interlock switch wiring to the Relay Junction Box.

keynote 63.526

A beam-off light may be controlled by the Clinac. Most sites do not use this feature. Route Warning Light wiring to the Relay Junction Box. Verify local requirements with regional regulatory agencies.

keynote 65.142

The required Relay Junction Box (RJB) provides an interface with the Varian Clinac via a factory assembled and tested control panel designed to provide a convenient, organized, labor saving central connection point for the Laser positioning system, status warning lights, room lighting, door interlocks, and remote emergency off pushbuttons. The panel includes wiring diagrams to enable it to be used as a radial junction and control point simplifying the connection of the various systems. The Relay Junction Box can be located above finished ceiling (if accessible) or flush mounted to the wall, near the Clinac Modulator Cabinet. The maximum conduit length from the RJB to the Modulator cannot exceed 45'-0" (13,716).

The required Relay Junction Box is available from GEXPRO

(800-200-9760 X3876 or 317-554-3876) Catalog #VRJB-C3 and ordering information is available from the Planning department web page: varian.com/architectural support or contact your regional Planning Manager.

keynote 69.047

A dedicated laser positioning lights power switch is optional. The laser positioning lights are controlled through the Relay Junction Box. Route wiring to the Relay Junction Box.

keynote 69.048

A room lights switch is optional. The room lights are controlled through the Relay Junction Box. Route wiring to the Relay Junction Box.

Printed Installation Data Package or Digital Installation Data Package (Adobe® Acrobat .PDF format)

The Varian Installation Data Package (IDP) consists of several sections. Each section contains detailed information about Varian equipment as listed below:

Section 1 Clinac 2100C(/D), 2300C/D, 21EX, 23EX, iX, Trilogy, Novalis Tx Equipment Information and General Information

Section 2 Clinac 600C(/D), 4EX, 6EX Equipment Information and General Information

Section 3 Acuity Simulator Equipment Information and General Information

Section 4 VariSource Equipment Information and General Information

Section 5 Treatment Planning - ARIA and Eclipse System Equipment Information and General Information

Section 7 Silhouette Edition Clinac- iX, Trilogy, Novalis Tx Equipment Information and General Information

Gating Section: Respiratory Gating Equipment Information and General Information including; Clinacs, Acuity, Ximatron and CT Scanners.

To obtain a printed copy of any of the Varian IDP's, contact the Varian Planning Department at the address below.

Digital Drawing Files

Available from the *Varian Web Page are Autocad .DWG and .DXF files for all sections of the IDP. These IBM PC-compatible files contain the Printed IDP details that are most useful for incorporation into the Architect's contract documents.

A Printed Installation Data Package or Digital Installation Data Package is required to use the Digital Drawing files.

Included in each self un-archiving file is the complete keynote database saved as a comma-delimited ASCII text file that can be inserted into most word processors, spreadsheets and databases. Each detail, as designated by a letter in the lower left corner, is saved in a separate file for easy insertion into the Architect's documents. A CAD file name can be found in the lower right corner of each detail. These files are provided by Varian to simplify the design and drafting process and must be modified by the Architect and Engineers to satisfy all site-specific conditions and regional regulations.

* Download Autocad DWG and DXF files from: [http://www.varian.com/onc/-support-architectural support](http://www.varian.com/onc/-support-architectural-support)

Limitation of Liability

Every effort has been made to keep these files consistent with the documents in the IDP. These files are provided "as is" without warranty of any kind, either express or implied. The Architects and Engineers of Record to reflect any and all site-specific conditions and regional regulatory agency requirements shall modify these files. Varian shall not be liable for the accuracy or completeness of the files, any documents that include portions of them or any damages, direct, indirect, incidental or consequential, including damages for any lost profits or project delays that result from the use of the files included herein.

Contact the Varian Planning Department if you have questions.

Varian Medical Systems
Planning Department
911 Hansen Way, Bldg. 3, M/S C-165, Palo Alto CA 94304-1028
Phone (800) 278-2747 (650) 424-5945 Fax (650) 424-6252

E-mail - planning@varian.com

*Download Autocad DWG and DXF files from: [http://www.varian.com/support-architectural support](http://www.varian.com/support-architectural-support)

**Varian Clinac 2100C/D, 2300C/D, 21EX, 23EX, iX, Trilogy, Novalis TX
Linear Accelerators Equipment Information**

	Doc #	Page #
<u>Table of Contents</u>	1100727	1.01
<u>Section Notes</u>	1101807	1.02
<u>General Information</u>		
Introduction to the Installation Data Package (IDP)	1100501	0.01
Terminology for Accelerator, Simulator and Remote Afterloader	1100503	0.02
Typical Design and Installation Timeline	1102372	0.03
Typical Department Plan	862455	0.04
<u>Drawings</u>		
Typical Room Shielding Tables	1100728	1.21
Typical Room Isometric View	1100730	1.22
Typical Room Configuration	861626	1.23
Overlay - Shipping Configuration	861652	1.24
Overlay - Plan View	861651	1.25
Overlay - Elevations	861654	1.26
Typical Control Equipment Casework	200072	1.27
Typical Remote Workstations	1100775	1.28
Laser Positioning Lights	1100767	1.29
General Room Storage Requirements	1100776	1.30
Typical Accessory Storage Dimensions	1100777	1.31
Typical Closed Circuit Television (CCTV) System	1100778	1.32
In-Room Monitor	1100791	1.33
Modulator Cabinet	861649	1.34
Base Frame Pit and Installation	861644	1.35
Base Frame Cable Access Details	1100737	1.36
Cable Access Diagram	1100738	1.37
Typical Lighting, Service and Safety Devices	1100739	1.38
Interconnection Wiring Diagram	200074	1.39
HVAC and Plumbing Requirements	862544	1.40
Varian-Supplied Component Information Table	1100740	1.41
Clinac Pre-Installation Checklist	1102371	1.42
Clinac Shipping List	1102394	1.43
Page Index	1101808	1.44
<u>Respiratory Gating Section Notes</u>		
Respiratory Gating - Typical Clinac Treatment Room	200001	G.1.0
Respiratory Gating - Clinac Interconnect Wiring	200002	G.2.0
Respiratory Gating - Camera Mounting Detail	200007	G.9.0
Respiratory Gating Pre-Installation Checklist	200010	G.10

"Clinac" is a trade name for Varian medical linear accelerators.

Section One Notes

Information and Support

This Installation Data Package (IDP) section describes only information on specific equipment facility requirements for Varian *Clinac* 2100C/D, 2300C/D, 21EX, 23EX, iX, Trilogy, Novalis Tx medical linear accelerators. Refer to the "General Information" section for an overview of the IDP and glossary of accelerator terminology. For more information, contact your nearest regional support office or Varian's main Planning Department at:

Varian Oncology Systems Marketing
Planning Department
911 Hansen Way, Bldg. 3 M/S C-165
Palo Alto, CA 94304-1028
(800) 278-2747
(650) 424-5945
(650) 424-6252 Fax
<http://www.varian.com> -architectural support

Varian/Customer Sales Contract specifics:

- Who shall provide final installation and grouting of Base Frame.
- Who shall provide and install the laser positioning lights.
- Who shall provide final utility (electrical and plumbing) connections to the equipment.
- Where is the utilities' interface point.
- Which party is responsible for the equipment rigging.

Equipment Options and Additional Services

To simplify the design process, we suggest that the Architect and Customer determine, as early as possible, all optional equipment configurations ordered or planned for the future. Below is a summary of the most common configurations, options and services ordered:

Clinac Linear Accelerator Models and Options

Clinac 2100C/D, 21EX.....	()
Clinac 2300C/D, 23EX.....	()
Clinac iX	()
Trilogy	()
Novalis Tx.....	()
Beamstopper	()
ARIA.....	()
PortalVision	()
Multileaf Collimator.....	()
On- Board Imager.....	()
Respiratory Gating	()
BrainLAB ExacTrac ©	()

Any Varian-provided third-party vendor items or services should also be discussed.

Other Optional Items/Services

Laser Positioning Lights	()
CCTV System.....	()
Power Conditioner	()
Equipment Rigging	()
Base Frame Grouting	()
Final Utility Connections.....	()

IDP Distribution

All participants in the process of designing a *Clinac* facility should be generally familiar with the entire IDP. As the central project manager, the Architect should control the distribution of all IDP materials. Below is an outline of the drawings in this section to which various parties should pay particular attention on a typical project:

- **Physicist** - Pages 1.21 and 1.23.
- **Architect** - This entire section.
- **Electrical Engineer** - Pages 1.23, 1.27, 1.28, 1.29, 1.32, 1.33, 1.34, 1.35, 1.36, 1.37, 1.38, 1.39 and the *Varian-Supplied Component Information Table*.
- **Mechanical Engineer** - Pages 1.23, 1.35, 1.40 and the *Varian-Supplied Component Information Table*.
- **Structural Engineer** - Pages 1.23, 1.24, 1.29, 1.34, 1.35, 1.38 and the *Varian-Supplied Component Information Table*.
- **Contractor** – To ensure that accurate, project-specific information is used for construction, the Contractor should obtain all information from the Architect's construction documents.

Typical Duties of the Parties

To help assure a trouble-free project, good communications between the Customer, Architect and Contractor, and a clear agreement with the assignment of responsibilities involved in the construction or remodeling of the *Clinac* room, we suggest inclusion of the following material in the appropriate sections of the Architectural Specification. Refer to the Customer/Varian *Terms and Conditions of Sale* and the Customer Purchase Order for a complete description of project-specific responsibilities.

The Customer shall:

- Provide As-Built Documentation (existing facility).
- Provide seismic testing for all supportive anchoring.
- Provide supervision and temporary services/facilities.
- Verify that the Varian Pre-Installation Checklist is completed.
- Provide equipment and material storage during construction.
- Provide Punch-List resolution and Warranty follow-up.
- Provide unloading space for forklift or crane and truck.

The Architect shall:

- Provide complete Architectural & Engineering Construction Documents for review.
- Provide Construction Documents.
- Provide Construction Regulatory Agency approval.
- Monitor conformance of the construction to the Construction Documents.
- Provide As-built documentation.

The Contractor shall:

- Provide structural alterations as required.
- Provide casework, cabinetry, doors or other millwork.
- Provide shielding and shielded door.
- Provide mechanical/electrical systems as required for room occupancy, including plumbing, fire protection systems, HVAC, compressed air, lighting and power distribution.

Section One Notes

The Contractor shall:

- Provide and connect mechanical/electrical utilities, as required for the *Clinac* operation, to an interface point.
- Provide monitoring systems including radiation detection, CCTV and intercom/telephone as selected by Customer.
- Request Base Frame shipment.
- Provide clear rigging route from the drop-off point to the room.
- Provide periodic and final cleanup.
- Remove Varian shipping crates.
- Pull Varian interconnect cables.
- Provide and pull network cables, where required.
- Maintain treatment room and control equipment area in a dust free and vandal-proof condition during *Clinac* assembly and run-up.

Varian shall:

- Provide *Clinac* equipment.
- Provide planning assistance.
- Provide Construction Document review.
- Provide periodic on-site inspection of work by others.
- Provide assembly and run-up.

Regulatory Requirements

- As stated in the Terms and Conditions of Sale, the Customer is responsible for obtaining all permits and for meeting all requirements relating to applicable state and local codes, registrations, regulations and ordinances affecting the Varian equipment.
- The radiation control regulations in several regions prohibit Varian from delivering equipment until the Customer can provide evidence of meeting certain requirements. Varian is often required to verify that Customers located in these regions have either licensed or registered their equipment and/or registered their facility before a machine can be delivered, installed, or released for clinical use. Customers should obtain their license or file their registration in a timely manner to avoid delivery and installation delays which can occur if these requirements have not been met.
- Varian must also verify that Customers located in certain regions have had their facility plan review approved by the regional radiation control agency before the delivery of equipment can be authorized. Customers are encouraged to submit their plan review to the appropriate agency early enough for Varian to verify compliance with these requirements well in advance of a scheduled delivery date.

- Questions about regulatory requirements should be directed to your regional radiation control agency. Documentary evidence of compliance with the above requirements or questions should be addressed to the Varian Regulatory Affairs Department.
Varian Medical Systems
911 Hansen Way
Palo Alto, CA 94304
Radiation Regulatory - (650) 424-6662
Regulatory Compliance - (650) 424-6398
- In accordance with Occupational Safety and Health Administration (OSHA) regulations, Varian provides with each *Clinac*, *Ximatron*, *Acuity* or *VariSource* a Material Safety Data Sheet (MSDS) packet which identifies hazardous substances used in these machines. If you require an advance copy of the MSDS packet for your machine, please contact your regional District Sales Manager or the Varian Safety Administrator at the following address:

Varian Safety Administrator
Oncology Systems
911 Hansen Way
Palo Alto, CA 94304

Information and Support

The purpose of the IDP is to aid Customers, Architects, Engineers and Contractors in their understanding of Varian equipment requirements and facility design issues.

The IDP consists of equipment sections as listed below:

- Section 1- Clinac 2100C/D, 2300C/D, 21EX, 23EX, iX, Trilogy, Novalis Tx
- Section 2- Clinac 600C(/D),6EX,4EX
- Section 3- Acuity Simulator
- Section 4- VariSource, GammaMed
- Section 5- Treatment Planning ARIA and Eclipse
- Section 7- Silhouette Edition Clinac (2100C/D, 2300C/D, 21EX, 23EX, iX, Trilogy, Novalis Tx)

For more information, contact your nearest regional support office or Varian's main Planning Department at:

Varian Medical Systems
 Planning Department
 911 Hansen Way, Bldg. 3 M/S C-165
 Palo Alto, CA 94304-1028
 (800) 278-2747
 (650) 424-5945
 (650) 424-6252 Fax
<http://www.varian.com> -architectural support

Digital IDP

Available from the *Varian Web Page are Autocad .DWG and .DXF files for all sections of the IDP. These IBM PC-compatible files contain the Printed IDP details that are most useful for incorporation into the Architect's contract documents. A Printed Installation Data Package or Digital Installation Data Package is required to use the Digital Drawing files.

Included in each self un-archiving file is the complete keynote database saved as a comma-delimited ASCII text file that can be inserted into most word processors, spreadsheets and databases. Each detail, as designated by a letter in the lower left corner, is saved in a separate file for easy insertion into the Architect's documents. A CAD file name can be found in the lower right corner of each detail. These files are provided by Varian to simplify the design and drafting process and must be modified by the Architect and Engineers to satisfy all site-specific conditions and regional regulations.

* Download Autocad DWG and DXF files from:
<http://www.varian.com> -architectural support

Keynotes

The drawings in the following section utilize keynotes to describe all non-graphic information. To simplify their use, these keynotes have been organized into the following general categories:

General Notes

- 10 General Notes

Layout Notes

- 20 General Layout Notes
- 21 Equipment Layout / Clearances
- 22 Rigging
- 23 Dimension Descriptions
- 24 Installation Notes

Finish Notes

- 30 Finishes
- 31 Control Equipment Casework
- 32 Room Storage Casework

Structural/Anchorage Notes

- 40 Base Frame Installation / Anchorage
- 41 Component Anchorage Brackets
- 42 Laser Positioning Light Mounting

Mechanical Notes

- 50 General Mechanical Notes
- 51 Plumbing
- 52 Coolant System
- 53 Ventilation
- 54 Compressed Air System
- 55 Fire Protection

Electrical Notes

- 60 General Electrical Specifications
- 61 Laser Positioning Lights
- 62 Room Lighting
- 63 Safety Device Systems
- 64 Cable Access Runs
- 65 Pull / Junction Boxes
- 66 Circuit Breakers / UVRs
- 67 Communications
- 68 Misc Electrical Components
- 69 Power Receptacles / Switches

Shielding Notes

- 70 Radiation Shielding
- 71 Other Shielding

Room Description Notes

- 80 Room Labels / Descriptions

Varian Component Dimensions, Weights and Other Information

Information regarding Varian-supplied components, such as weights, dimensions, wattage and decibel output levels, is located on the *Varian-Supplied Component Information Table* at the end of this section.

The Planning Department provides:

Standard and Supplemental Data

Installation Data Package (IDP) - This package contains equipment and facility information required by the Customer, as well as the Customer's Architect, Engineers and Contractor. The IDP outlines the facility requirements to insure the quick and efficient installation of Varian equipment. All information provided in the IDP shall be processed by the Customer's Design Professionals for local regulatory agency and site-specific facility requirements. This information must then be incorporated into the Construction Documents. Since Varian equipment does not require modification to suit specific sites and all facility requirements are defined in the IDP, Varian does not provide shop drawings.

Supplemental Information - There are many supplemental documents available from the Planning Department's web page
<http://www.varian.com> -architectural support

Typical documents available include:

- AutoCAD drawing files.
- Sample Seismic Calculations - These are available on request for all *Clinac* and *Acuity* models. These studies analyze the forces acting on the equipment's base frame connection to the floor.
- Specialized shielding documents.
- Third Party specification documents.

Site-specific Support

All site-specific documents supplied by Varian are provided to aid the Customer during the facility design and construction document preparation processes. These documents are intended to supplement the IDP with site-specific recommendations only. They do not provide additional engineering information and are not construction documents. All information provided in the IDP shall be processed by the Customer's Design Professionals for local regulatory agency and site-specific facility requirements. This information must then be incorporated into the Construction Documents. Since Varian equipment does not require modification to suit specific sites and all facility requirements are defined in the IDP, Varian does not provide shop drawings.

Preliminary Department Plan Review – The planning Department will require a preliminary plan of the proposed department. Upon receiving the plan we will comment on the following: Circulation paths, rig paths, special relationships, control area size and configuration, accelerator and or simulator room size and configuration. Upon request Varian can supply to our Customer or the Customer's Design Professionals examples of various department floor plans ranging in size and configuration including one or multiple vault layouts.

Proposal Drawing - This drawing shows the equipment in the proposed room in both plan and cross-section. It includes a shielding analysis of the equipment room with the proposed equipment. Any recommended additions to existing shielding are shown. It also includes recommendations for a schematic console layout, cabinets, sinks and support equipment as well as references to the appropriate sections of the IDP for these items. Where there are required site-specific variances to the information in the IDP (usually on existing facilities), additional information may be shown on this drawing. The Planning Department requires a dimensioned floor plan (or an extracted DWG or DXF CAD file of the specific area) room section, existing or proposed shielding layout and existing utility information.

Site Visit by Planning - In special circumstances, a Planning Department or other Varian representative will visit the site to review the facility or to consult with the Customer, Architect, and Engineers.

Construction Document Review - The Review of the Customer's construction documentation is usually Planning Department's final contact with the project. In this review the architectural and engineering documents are checked to determine that the required additions or modifications to the facility are appropriate for Varian equipment. Varian checks only for those items that affect the operation of our equipment. Varian does not check for compliance with

various regulatory agency requirements. The review is made to the extent that the submitted plans allow. This does not include verification of the adequacy of radiation shielding, which must be approved by the facility's Physicist of Record. The review does not constitute nor imply approval of either the architectural or engineering documents. Varian expressly denies any responsibility for the accuracy or adequacy of the construction documents prepared by the Customer's design consultants.

North American Architectural Planning Support

To obtain further Architectural support or information contact:

Western Region - Main Office

Varian Medical Systems
 Planning Department
 911 Hansen Way, Bldg. 3 M/S C-165
 Palo Alto, CA 94304-1028
 (800) 278-2747
 (650) 424-5945
 (650) 424-6252 Fax
<http://www.varian.com> -architectural support

Central Region

Varian Medical Systems
 Planning Department
 403 International Parkway, Suite 503
 Richardson, TX 75081
 (972) 238-1855
 (972) 644-2681 Fax

Northern Region

Varian Medical Systems
 Planning Department
 2397 Hawthorne Drive
 Yorktown Heights, NY 10598
 (914) 243-2953
 (914) 243-2953 Fax

Southern Region

Varian Medical Systems
 Planning Department
 2250 Newmarket Parkway, Suite 120
 Marietta, GA 30067
 (678) 255-3838
 (678) 255-3850 Fax

International Support

<http://www.varian.com> -architectural support



PLANNING REGIONS

North American Regional Installation Offices

An Installation Project Manager inspects the on-site conditions and construction preparations. The Project Manager also supervises critical construction phases, such as base frame installation and final connections. All Planning Department correspondence will identify the Installation Project Manager for the project site. The regional office locations are:

Northern Region

Regional Installation Project Manager
 Varian Medical Systems Service
 200 East Howard Street, Suite 202
 Des Plaines, IL 60018
 (847) 296-0660
 (847) 296-8316 Fax

Southern Region

Regional Installation Project Manager
 Varian Medical Systems Service
 2250 Newmarket Parkway, Suite 120
 Marietta, GA 30067
 (770) 955-1775
 (770)984-6249 Fax

Education Department

For information regarding Varian training courses, contact:

Education Department

Varian Medical Systems
 6883 Spencer Street
 Las Vegas, NV 89119
 (702) 938-4800
 (702) 938-4805 Fax

North American Regional Sales Offices

The Varian Sales Manager is most familiar with the specific equipment order information. To verify equipment ordered, including specific options to be provided, contact either the Customer or the District Sales Manager. The regional office locations are:

Atlanta, Georgia

Varian Medical Systems
 2250 Newmarket Parkway, Suite 120
 Marietta, GA 30067
 (770) 955-1367
 (770) 984-6249 Fax

Chicago, Illinois

Varian Medical Systems
 200 East Howard Street, Suite 202
 Des Plaines, IL 60018
 (847) 296-5533
 (847) 296-0043 Fax

New Jersey

Varian Medical Systems
 100 Walnut Avenue
 Clark, NJ 07066
 (732) 381-5300
 (732) 381-1060 Fax

Southern California

Varian Medical Systems
 650 East Parkridge Suite 109
 Corona, CA 92879
 (909) 280-4401
 (909) 280-4300 Fax

Acuity® - Varian trade name for its **simulator**. The simulator is used to assist with treatment planning for determining the method and position to use during actual treatment.

Arc Therapy - A form of radiation therapy in which the radiation beam is continuously directed toward the isocenter as the linear accelerator **Gantry** is rotated in an arc.

ARIA - An advanced information platform designed to unify the clinical and administrative aspects of radiation oncology. This Varian product consists primarily of software that will run on Customer or Varian-supplied computer hardware. The effect of ARIA system on the architectural requirements is limited to an increase in the control console size requirement. The *Clinac* and *Acuity* Workstations can be linked by the Network Fileserver to form a local area **Network**. Editing Workstations are optional stations located away from the *Clinacs* and/or *Acuity* consoles. See also **Network**.

Attenuation - The reduction of intensity upon passage of radiation through a medium caused by absorption and scattering.

Backpointer Laser - A linear accelerator accessory, usually mounted to the **Gantry**, used to identify the central axis of the radiation beam.

Base Frame/Plate - Varian-supplied assembly that anchors the **Stand/Gantry** and the **Couch**, to the building structure.

Beamstopper - Optional fixed or retractable attachment for the *Clinac* designed to attenuate the primary beam. A *Clinac* equipped with a Beamstopper does not require primary beam shielding. Rooms for *Clinacs* equipped with a Beamstopper can be designed for leakage/scatter (**Secondary**) radiation shielding only. When the **Gantry** is rotated to certain positions, the Beamstopper may interfere with movements of the couch. The presence of a Beamstopper may preclude the addition of some accessory options. Consult with the Regional Varian District Sales Manager regarding accessory restrictions.

Blocks and Block Trays - Accessories used to shape the treatment field. Blocks are custom made for each patient and are supported by the Block Tray at the *Clinac* **Collimator**. 40 to 100 Block Trays may be in use daily.

Breakdown - The manner in which a *Clinac* is disassembled for shipment. Three-piece breakdown leaves the **Stand** and **Gantry** connected. A four-piece breakdown separates the **Stand** and **Gantry**, and is used to shorten the space required for passage into the treatment room. The four-piece breakdown involves extra cost.

CCTV - A closed-circuit television is used for observing patients from the control console. The system can be color or black-and-white and consists of one or two cameras and one or two monitors. Verify quantity of cameras required with regional regulatory agencies. The primary camera will normally include an auto-focus and low-light level lens with power zoom. It will be mounted on a bracket incorporating pan-tilt features. The control console must include remote controls for the zoom and pan-tilt.

Circuit Breaker - A device designed to open the circuit automatically at a predetermined over current without damage to itself or the protected device it serves.

Clinac® - Varian trade name for a range of Linear Accelerator models used in cancer treatment and stereotactic radiosurgery. Low Energy (600C, 4EX, 6EX and 600SR) models have different facility requirements from Dual Energy (2100C/D, 2300C/D, 21EX, 23EX) models. Re-built *Clinacs* (4R, 6XR and 18R) have similar characteristics to the in-production models.

Collimator - A movable, radiation-limiting device, located in the head of the **Gantry**, used to define the radiation field.

Computerized Tomography (CT) - Technique for making computer-generated images of a predetermined plane section of a patient's body by rotating an x-ray tube around a patient.

Cone - See **Electron Applicator**.

Control Equipment Casework - Casework designed to accommodate Varian control equipment and workstations. The **Control Equipment Casework** is located outside the *Clinac* or *VariSource*, *GammaMed* room and usually located behind a wall within the *Acuity* room. The control equipment is used for setting mechanical and treatment parameters.

Couch - The assembly used to support the patient during treatment or simulation. It can move vertically, longitudinally and transversely to position the patient treatment field at **Isocenter**. The minimum travel radius must be free of obstructions. Its maximum travel radius defines the maximum distance from isocenter throughout its travel range that the **Couch** can operate. As the couch is seldom used in all orientations, the maximum travel radius can have obstructions without detriment, but it is recommended that the Customer and Varian's Planning Department be consulted.

Door Interlock - A switch that enables a fail-safe safety circuit linked to the *Clinac*, *VariSource*, *GammaMed* or *Acuity* when the door to the room is closed. The door must be closed before radiation treatment or simulation can proceed. If the door is opened during treatment or simulation, the beam is turned off.

Dynamic Wedge - An accessory used to generate a wedge-shaped isodose contour, analogous to physical wedges, by moving one of the **Collimators** during the course of an x-ray treatment.

Dynamic Compensation - A superset of the **Dynamic Wedge** where one or more mechanical axes move during the course of an x-ray treatment to conform the dose distribution to the treatment volume. This technique can affect the room barrier shielding design.

Electron Applicator - An accessory, often called a "cone" that is mounted to the *Clinac* or *Acuity* **Collimator** that defines the treatment field for electron therapy. These are required for the Dual Energy *Clinacs* and are optional with the *Acuity*s. There are five, and one additional optional, units per set. They measure approximately 1'-0"x1'-0"x1'-4" (300x300x400) and weigh up to 20 lbs. (9kg) each. Their storage requires special design attention when it is incorporated into the treatment and **Simulator** room cabinetry.

Electron Radiation - A **Primary Beam** of radiation generated by the *Clinac* for treatment. Low energy *Clinacs* have no electron mode, while dual energy *Clinacs* have several selectable electron energies. **Electron Radiation** is less penetrating than **Photon Radiation**, and is used less often than **Photon Radiation**.

Electronic Cart Assembly - The **VariSource Transportable 200t** system comprises the VariSource Remote Afterloader (VRA) and Electronic Cart Assembly (ECA). The ECA houses the VariSource, GammaMed Control Console and Treatment Planning System plus peripherals and storage for accessories. The ECA and VRA form a single articulated vehicle facilitating transport and installation once at the designated site. This ECA is connected via Varian supplied cables to the Wall Box and the grounded duplex electrical power receptacle located in the control console area.

Emergency-Off Switch - A "mushroom" button used to disable the *Clinac*, *VariSource*, *GammaMed* or *Acuity*. The switch must have a manual reset feature. Emergency-Off switches are provided at equipment **Stand**, **Couch**, and Modulator **Cabinet**. Additional switches must be provided to disable the *Clinac* without entering the **Primary Beam** and in accordance with local regulations.

Experimental Access Conduit - The installation of an experimental access (physics) conduit between the interior of a *Clinac* or *VariSource*, *GammaMed* treatment room and an accessible point outside the treatment room, may be requested by the Customer. It is used periodically with a **Water Phantom/Beam Scanner System** in *Clinac* treatment rooms. The conduit should be oriented as perpendicular to the isocenter as possible.

Eyebolt - A bolt with a looped head used to suspend the **Couch** during maintenance. Three are recommended for new construction and are located over the **Isocenter**. Retrofitting eyebolts to existing concrete structures is not recommended.

Final Field Defining Aperture (FFDA) - An accessory that is fabricated to shape a patient's electron beam treatment field. It installs into the **Electron Applicator** during patient set-up.

Fluoroscopy - Real-time imaging by means of a fluoroscope, which is a device used for viewing patients during simulations. Fluoroscopic capability is a standard feature of the *Acuity*.

Freight - Refers typically to the shipment of Varian equipment, beginning with the pick-up at the factory and ending freight-on-board (FOB) at the facility. See also **Rigging**.

GammaMed – See *VariSource*

Gantry - Rotating part of the **Stand/Gantry** assembly. The *Clinac* Gantry contains the accelerator guide, bending magnet (Dual Energy *Clinacs*) and **Collimator**. The *Acuity* Gantry contains the x-ray tube.

In-Room Monitor - Display that describes the status of the equipment setup and patient parameters. The staff uses this monitor in the treatment room as they set up the patient. It is important to locate the monitor such that viewing the monitor during the Setup process shall not distract the therapist from the patient. Consult with the Customer regarding monitor location preference. The In-Room monitor should not be located in any x-ray primary beam.

Intercom - Two-way electronic communication device used to monitor the patient audibly in the treatment room from the control console during treatment. The intercom is important for dialog between the therapist setting the patient up and the radiation equipment operator, and to monitor the patient when the therapist is out of the treatment room. The intercom should have duplexing and be voice-activated or continuous-on in the room and push-to-talk at the control console. When the *Acuity* and its console are in two adjacent areas with no door between, an intercom may not be needed.

Isocenter - The point in three-dimensional space about which the **Gantry**, **Collimator** and **Couch** turntable rotate in common. This point is the central reference for all calibrations and critical shielding dimensions. It is a guide for positioning the **Base Frame** pit, **Lasers**, **Couch**, *Clinac/Acuity* and the patient during treatment procedures.

Junction Box - A conduit body that is used to access and terminate conductors or house an electrical device. For purposes of *Clinac* and *Acuity* requirements, the Varian-supplied cables are pulled and housed in conduits terminated at **Pull Boxes**, while the lighting control relays are housed in a junction box.

Laser Positioning Lights - Laser devices used to position the patient on the couch for treatment or simulation. Four lasers are used in the treatment room. Their light beams intersect at the isocenter. The side and overhead lasers throw both vertical and horizontal beam planes that create a crosshair. The sagittal laser is located ahead of the **Couch** and at least seven feet above the floor and throws only a vertical beam plane. Rigid installation of the lasers is critical. A back pointer laser, which is mounted on the **Gantry** counterweight or beamstopper, may be ordered with the equipment. The back pointer laser, along with the wall-mounted lasers, creates an intersection of light defining the radiation exit axis.

Last Man Out - See **Search/Evict**.

Maze - A treatment room entrance hallway designed to reduce radiation levels, particularly neutrons, at the entrance door. The length of and occupancy beyond the maze affects the amount of shielding required in and around the door.

Modulator Cabinet - Power control unit for all Dual Energy *Clinacs*. The Modulator is located in the cabinet behind the machine. Cable length should be considered relative to the console.

Multileaf Collimator (MLC) - Collimator system designed to define the silhouette of a beam of radiation. This optional system, only available for the 600C, 2100C, 2100C/D and 2300C/D *Clinacs*, reduces the need for blocks and block trays. The effect of the MLC system on the architectural requirements is limited to an increase in the control console requirements.

Network - A system of interconnected computers. A computer network usually links two or more personal computers (Workstations) to a centralized storage device (File Server). Networks provide users at different locations with the capability to share software, information and peripheral devices, such as printers. See **ARIA**.

Neutron Radiation - A particle form of Secondary Radiation produced by high (≥ 10 MV) energy photons incident on high atomic number materials such as steel and lead.

Occupancy - The purpose or activity for which a space is used with regard to an occupant's length of stay while radioactivity is present. The values used for determining requirements in Varian documents are: 0% for no occupancy within a 60 foot (18,300) radius from the radiation source; 10% for exterior areas; 25% for service or circulation areas; 50% for treatment, exam and waiting areas; 100% for control, office or areas of unknown occupancies.

Pendant - Hand-held remote control unit attached to the **Couch** that is used to position and adjust the **Couch**, **Gantry** and **Collimator** for patient treatment. The Pendant also houses controls for room lights and **Laser Positioning Lights**.

Photon Radiation - A Primary Beam of low (< 10 MV) or high (\geq 10 MV) energy penetrating x-ray radiation generated by the *Clinac* for treatment. Low energy *Clinacs* have a single x-ray energy of less than 10 MV, while dual energy *Clinacs* have one similar low energy, and one high energy x-ray energy of 10 MV or greater. The term "Photon Radiation" also refers to the x-ray leakage radiation and scatter radiation that is either emitted from the *Clinac* or scattered from the shielding barriers, respectively.

Physicist of Record - The physicist with the responsibility for assessing parameters and limits associated with the *Clinac* or *VariSource*, *GammaMed*. With regard to facility shielding, the **Physicist of Record** is responsible for designing the treatment room radiation shield barriers and confirming they meet applicable regulatory requirements. The facility design is based on regulatory requirements of the regulatory body tasked with oversight of Radiation Producing Devices in the Region, and recommendations of the National Council of Radiation Protection and Measurement (NCRP). Confirmation of the shielding adequacy is assessed with a radiation survey performed by a qualified physicist, which may or may not be the **Physicist of Record**. The **Physicist of Record** will correspond with the Region's Department of Health Services (or equivalent) regarding the design and results of the radiation survey.

PortalVision (PV) - Real-time imaging system for monitoring and verification of treatment field and shielding blocks in relation to anatomical landmarks. The effect of PortalVision on the architectural requirements is limited to an increase in the control console requirement.

Power Panel - An assembly of circuit protection and control devices.

Primary Beam Radiation - The emission or propagation of photons or electrons along the main axis or direction of the generating equipment (see **Photon Radiation** and **Electron Radiation**). *Clinacs* generate a 28-degree **primary radiation** beam cone from a source in the **Gantry** (measured one meter back from isocenter). *Acuity* generates a 39-degree **primary radiation** beam cone from a source in the **Gantry** (measured one meter back from isocenter). Shielding for the primary beam must consider the 360-degree rotation of the **Gantry** and should extend at least one-foot (300) beyond the beam cone.

Pull Box - A conduit body that is used only to access conductors. The distinction is made to simplify the NEC or other regulatory agency requirements for placement and construction of these structures. The **Control Console**, **Base Frame**, and **Modulator** boxes are Pull Boxes, as no termination of conductors is made in them.

Radiation monitor/detector - Device that senses radiation and issues a warning when the radiation level exceeds the preset standards. Some jurisdictions require them in accelerator rooms as a precautionary measure.

Radiosurgery - A method of treatment that uses a single, high dose of radiation to alter the tissue to cause necrosis or fibrosis. This procedure uses **Gantry**, and sometimes **Couch**, movement during the treatment to minimize exposure to surrounding tissue.

Radiotherapy - A method of treatment using multiple, small radiation doses to gradually shrink and kill malignant tumor cells.

Relay - Automatic electromagnetic or electromechanical device that responds to a small current by activating switches in an electric circuit. **Lasers** and room lights are connected through relays to the switches in the **Pendant** and on the **Couch**.

Rigging - Positioning of the **Base Frame** and the *Clinac*, *VariSource*, *GammaMed* or *Acuity* components into the treatment room. The Base Frame is rigged prior to the rest of the equipment. A rigging company is usually hired by the Customer to off-load these items from the truck and to move them through the facility into the treatment room. The Customer's architect and structural engineers must review the entire rig route for adequate clearances and structural support. The work can include temporary demolition and shoring. Final equipment positioning is part of the rigging contract. See also **Freight**, and **Breakdown**.

Safety and Monitoring Devices - Special equipment required to assure that the technical and service personnel are not exposed to radiation. These items are **Emergency-Off Switch**, **Radiation Monitor/Detector**, and **Warning Light**. (See definitions.) Other monitoring equipment is used to observe and position the patient during treatment. These items are **CCTV**, **Intercom**, **Laser Positioning Lights**, and **View Window**. (See definitions.)

Search/Evict - A procedure, usually involving some form of electro-mechanical interlock to the equipment, which provides added assurance that only the patient is in the room during treatment. (Also called "Last man out" procedure.)

Secondary Radiation - The emission or propagation of neutrons and/or photons as a result of bouncing or reflecting in various directions. Its sources are leakage from the equipment head and scatter from the room surfaces. (see **Electron Radiation**, **Neutron Radiation** and **Photon Radiation** above)

Simulator - Radiotherapy equipment, such as the Varian *Acuity*, that uses radiographic and fluoroscopic imaging to duplicate the beam geometry of medical linear accelerators as a means to localize the treatment field.

Stand - Fixed part of the **Stand/Gantry** assembly containing the Klystron, power converters, cooling water heat exchanger, microwave generator and other elements of the linear accelerator and similar components of the *Acuity*.

Start Button - An override connected to the **Emergency-Off** circuit and to a separate, interim power source, which allows interim power to close the **UVR** circuit until *Clinac* power is available.

Stereotaxis (n), **Stereotactic** (adj) - The principle of locating a point in three dimensional space, within the brain, with a high degree of accuracy, by using an external reference coordinate system or plane.

T-switch - A device used to switch the In-Room Monitor presentation between the Control Console display (C-Series only) and the **ARIA** display.

Total Body Irradiation (TBI) - A technique during which a large-field x-ray or electron beam is used to treat the entire patient's body. Due to the increased field size, a distance of 10 to 20 feet (3 to 6 meters) is required from the isocenter to the wall on one side of treatment rooms designed to accommodate the procedure.

Under Voltage Release (UVR) - Safety feature that trips the breaker when an under-voltage condition occurs. Used in conjunction with Clinac and Acuity emergency off circuits to trip the main circuit breaker power to the equipment.

VariSource - Varian's high dose rate remote afterloader delivers high radiation doses to patients by way of a radioactive source wire that is extended through catheters into body cavities.

View Window - Patient monitoring opening in the wall between the **Control Equipment Casework** and the *Acuity* room spanned with leaded glass. Low energy accelerators occasionally have view windows but this is not recommended.

Warning Light - A light (usually red) that indicates "beam-on" condition. A light for "ready" mode may be required also.

Water Phantom/Beam Scanner System - A clear tank, part of a set of components, used to simulate a human body on the treatment couch to determine an accurate radiation output and dose distributions of a linear accelerator. The water phantom, which measures up to 2'-0" x 2'-0" x 2'-0" (600 x 600 x 600), is used by the therapists and physicists. It needs to be filled with water before use and the water needs to be siphoned off after use. Water supply, drain, and water-resistant storage space for the tank should be provided within the treatment room.

Customer		A	B	C	D	E	F	G	H	I	J	K	L	M	N
1	Plan Review														
2	Issue Purchase Order														
3	Drawing Review														
4	Physicist Shielding Review/Source Lic.														
5	Construction Administration														
6	Radiation Test and Survey														
7	System Acceptance														
8	Clinical Operation Begins														

Varian - District Sales Manager 10.630

1	Initial Sales Contact														
2	Formal Price Proposal														
3	Sales Contract/Installation Request														
4	Available by Phone														

Varian - Planning Department 10.631

1	Installation Data Package Sent														
2	Proposal Drawing/Shielding Review														
3	Construction Document Review														
4	Site Visit (if required)														
5	Provide Phone Support														

Varian - Installation Coordination 10.632

1	Installation Request Received														
2	Construction Site Visit														
3	Order/Install Base Frame														
4	Pre-Installation Checklist Completed														
5	Coordinate Clinac/Acuity Delivery														
6	Coordinate HDR Delivery														
7	Coordinate ARIA Delivery														
8	Coordinate MLC/PortalVision Delivery														
9	Coordinate Eclipse Delivery														
10	Equipment Acceptance Testing														
11	Coordinate Application Training														

Varian - Clinical Support 10.659

1	Application Training Services														
2	Customized Capabilities Offerings														

Varian - Customer Support 10.633

1	Warranty / Service														
---	--------------------	--	--	--	--	--	--	--	--	--	--	--	--	--	--

Architect/Engineer 10.634

1	Schematic Design														
2	Architect/Engineer Review														
3	Design Development														
4	50% Construction Documents														
5	95% Construction Documents														
6	100% Construction Documents														
7	Construction Administration														
8	Project Close Out														

Contractor 10.635



1	Construction Bid														
2	Construction Contract														
3	Construction														
4	Request Base Frame														
5	Pre-Installation Checklist Complete														
6	Final Utility Connections														
7	Install Finish Flooring														

Regulatory Agencies 10.636 70.574

1	Plan Review														
2	Plan Approval														
3	Inspections as Required														
4	Agency Approval														

A Typical Site Preparation Process 10.627

IDP10001

	 Refer to the Varian Components chart at the end of this section.	Typical Site Preparation Process Clinac / Acuity / VariSource/GammaMed / ARIA / Eclipse				
	Not For Construction					
0.03.0 :page	planning dept.	© Varian Medical Systems 2008 All rights reserved.	31Mar08	revision: 3	doc. #: 1102372	page: 0.03.0

10 - General Notes

10.627

The Typical Site Preparation Process diagram is provided to assist the Customer in the early project planning stages. This diagram can be labeled or modified to reflect a project's specific schedule.

10.628

These items apply only to Clinac and Acuity projects.

10.629

The Customer is responsible for coordinating program requirements with the intended equipment users and the Architect. The Customer should review with the Architect the specific equipment and options ordered as well as any future considerations. All physics design, testing and acceptance coordination is the responsibility of the Customer.

10.630

The Varian District Sales Manager is the primary Customer contact during pre-sale activities.

10.631

The Varian Planning Department provides Customer site preparation support from pre-sale to the start of construction. Site specific drawings, site review, technical phone support and document review are services available to the Customer and the Customer's design representatives.

10.632

The Installation Project Manager becomes the Customer's primary contact from the start of construction to the start of the equipment installation. The Installation Project Manager's responsibilities include the coordination of equipment delivery and installation, technical phone support, shipping notice distribution, verification of pre-installation checklist items and scheduling of product training.

10.633

The Varian Customer Support representatives provide warranty and service support.

10.634

The Architect and Architectural Engineers provide design, documentation and construction administration services to the Customer. The Architect should be the Customer's primary representative for the distribution of Varian provided information during the entire design and construction phases. The Architect should send periodic construction document sets to the Planning Department for review prior to the construction bidding process.

10.635

The Building Contractor is the Customer's representative for construction services.

10.636

Submittals to the required Regulatory Agencies is the responsibility of the Customer. Varian does not check submitted documents for compliance with regional building codes or other regulatory requirements.

10.659

The Clinical Support Department provides on-site instruction (both basic and advanced) on Varian products. Customized capability offerings provide implementation and organizational assistance for new technology and system development.

70 - Radiation Shielding

70.574

Prior to source distribution, Varian is required to verify that Customers have a license to possess and use the source with the high dose rate remote afterloader. Prior to receiving a source, Customers shall provide Varian with a current copy of their license indicating the maximum activity allowed for use.

	[000] Refer to the Varian Components Chart at the end of this section.	Typical Site Preparation Process Clinac/Acuity/VariSource/GammaMed/ARIA/Eclipse				
	Not For Construction					
0.03.1 :page	planning dept.	© Varian Medical Systems 2008 All rights reserved.	31Mar08	revision: 3	doc. #: 1102372	page: 0.03.1

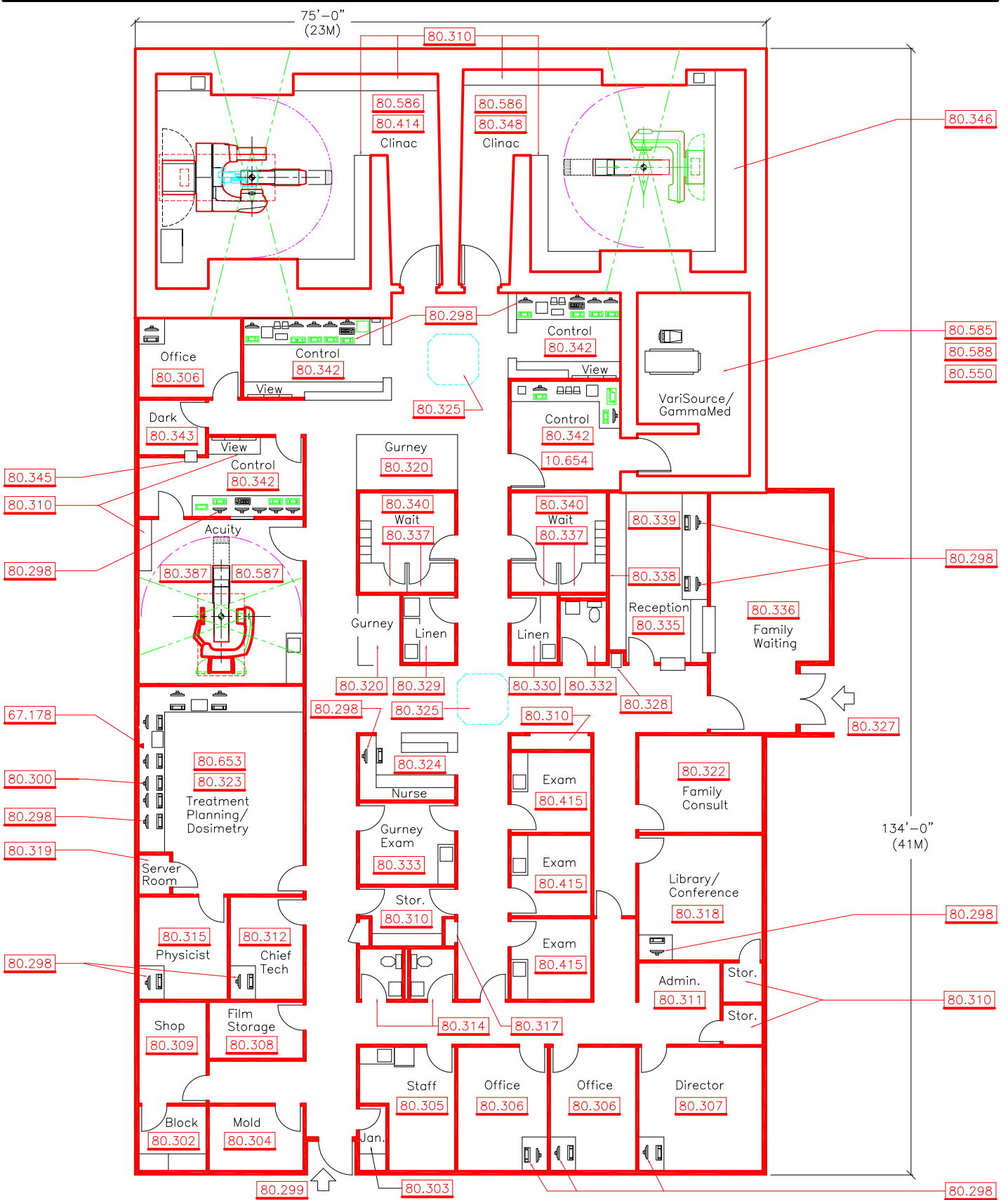

A Typical Department Plan 10,050 Sq Ft (943 Sq Meters) 80.347 80.647 IDP10002

scale at:	1 = 200	0	4	8	12	16	20	24
	1/16" = 1'-0"	0	4	8	12	16	20	24

	000 Refer to the Varian Components chart at the end of this section.	Typical Department Plan Clinac / Acuity / VariSource/GammaMed / ARIA / Eclipse				
	Not For Construction					
0.04.0 :page	planning dept.	© Varian Medical Systems 2008 All rights reserved.	31Mar08	revision: 5	doc. #: 862455	page: 0.04.0

10 - General Notes

10.654

The VariSource Transportable 200t system comprises the VariSource Remote Afterloader (VRA) and Electronic Cart Assembly (ECA). The ECA houses the VariSource Treatment Control Console And Treatment Planning System plus peripherals and storage for accessories. The ECA and the VRA form a single articulated vehicle facilitating transport and installation once at the designated site. This ECA is connected via Varian supplied cables to the Varian Wall Box and the grounded duplex electrical power receptacle located in the control console area.

The GammaMed Transportable system comprises the GammaMedplus Remote Afterloader (GRA) and the GammaMedtrolley (Trolley). The trolley houses the GammaMed Control Console and Treatment Planning system plus peripherals and storage for accessories.

The Trolley and GRA form a unified vehicle facilitating transport and installation once at the designated site. This Trolley is connected via Varian supplied cables to the Junction Box and the grounded duplex electrical power receptacle in the control console area.

67 - Communications

67.178

A dedicated analog modem phone line is required at the location of the ARIA System Administrator Workstation.

80 - Room Labels / Descriptions

80.298

ARIA Workstations may be located throughout the department and are linked via a network.

80.299

A secondary entrance is usually provided for use by staff and for ambulance patient access.

80.300

Treatment planning computer with film digitizer.

80.302

The Block Cutting room contains tools that are used to make patient lead blocks. A ventilation hood is required. Typical room size is 60 sq. ft. (5.5 sq.M.).

80.303

Janitor's Closet.

80.304

The Mold Room is a work room where patient immobilization devices are made. Typical room size is 150 sq. ft. (13.9 sq.M.).

80.305

The Staff Room is used by department staff for breaks and conferences. Typical room size is 150 sq. ft. (13.9 sq.M.).

80.306

Several Offices are required in the department. Typical offices include a Physician's Office and a Nurse's Office. Typical room size is 90 sq. ft. (8.4 sq.M.).

80.307

The Director's Office should be located adjacent to other staff offices and administrative support. Typical room size is 150 sq. ft. (13.9 sq.M.).

80.308

The Film Storage and Viewing Room is where RTs and Dosimetrists store and analyze patient films to determine and review treatment plans. Typical room size is 60 sq. ft. (5.5 sq.M.).

80.309

The General Shop Area provides equipment, working area and storage space for patient restraint and other department devices. Typical area size is 150 sq. ft. (13.9 sq.M.).

80.310

General Storage areas should be provided at convenient locations.

80.311

A Department Administration Area is used for staff administrative support services. Typical area size is 100 sq. ft. (9.2 sq.M.).

80.312

The Chief Therapist's Office should be located close to the vaults and exam rooms. Typical room size is 120 sq. ft. (11.1 sq.M.).

80.314

The Staff Toilet Room is an area where staff can change and clean up. Typical room size is 80 sq. ft. (7.4 sq.M.).

80.315

The Physicist's Office should be located near the Treatment Planning and Equipment rooms. Typical room size is 120 sq. ft. (11.1 sq.M.).

80.317

Clean Linen storage should be provided adjacent to the exam rooms.

80.318

The Library / Conference area can be used for meetings of physicians, staff, support groups, etc., and also houses patient and family informative support literature. Typical room size is 150 sq. ft. (13.9 sq.M.).

80.319

The ARIA/Eclipse Servers should be located in an air conditioned server room or well ventilated central location. Routine access to the Server is usually not required, except by authorized service personnel. Depending on purchased options there could be 1-4 servers.

80.320

The Gurney Hold area is located near the staff so they can observe the inpatients on gurneys, shielded with a curtain, away from the outpatients. Typical room size is 40 sq. ft. (3.7 sq.M.).

80.321

The Handicap Access Toilet is located proximate to the Dressing and Simulator Rooms as some patients are nervous or nauseous. Typical room size is 45 sq. ft. (4.1 sq.M.).

80.322

The Family Consultation Room is where physicians may meet with patients and their family to discuss the patient's treatment plan. Typical room size is 150 sq. ft. (13.9 sq.M.).

80.323

The Treatment Planning / Dosimetry room houses computer equipment used by the dosimetrist to determine treatment plans for each patient. Typical room size is 600 sq. ft. (55.7 sq.M.).

80.324

The Nurse's Station is a central control point where nurses coordinate patient and staff flow/interaction. Typical room size is 80 sq. ft. (7.4 sq.M.).

80.325

Skylights may be used to improve the aesthetic working and treatment environment. Care should be taken to avoid glare on computer monitors.

80.327

The Main Entrance is used by outpatients and their families.

80.328

A Drinking Fountain should be provided adjacent to the family waiting area.

80.329

The Soiled Linen area is located close to the exam suite, where soiled bed linens and towels are held prior to laundry/sterilization. Typical room size is 40 sq. ft. (3.7 sq.M.).

80.330

The Clean Linen area is located close to the exam suites where clean bed linens and towels are stored. Typical room size is 40 sq. ft. (3.7 sq.M.).

80.332

The Public Toilets are for use by those in the waiting room. Typical room size is 45 sq. ft. (4.1 sq.M.).

	[000] Refer to the Varian Components Chart at the end of this section.	Typical Department Plan			
	Not For Construction	Clinac/Acuity/VariSource/GammaMed/ARIA/Eclipse			
0.04.1 :page	planning dept.	© Varian Medical Systems 2008 All rights reserved.	31Mar08	revision: 5	doc. #: 862455 page: 0.04.1

80.333

The Gurney Exam Room is used by the RTs and nursing staff to see gurney patients for examination, consultation and treatment procedures. Typical room size is 110 sq. ft. (10.2 sq.M.).

80.335

The Cashier/Reception area is where patients register and arrange for payments. Typical room size is 100 sq. ft. (9.2 sq.M.).

80.336

The Family Waiting Area is a primary waiting area for patients, family and friends. It is comfortable, spacious, and furnished with diversions.

80.337

A Dressing Room provides an area where patients dress and wait prior to treatment. Treatments continue typically for 5 to 7 weeks. Typical room size if 40 sq. ft. (3.7 sq.M.).

80.338

Provide space for patient Files.

80.339

The Business Office houses the Facility Business Manager who is responsible for the effective operation of the Center. Typical room size is 120 sq. ft. (11.1 sq.M.).

80.340

The Patient Dressing / Gowned Waiting area is where patients wait prior to treatment. The typical size of this area is 150 sq. ft. (13.9 sq.M.).

80.342

The Control Equipment Area is located in close proximity to the treatment vaults or within the simulator room, and centrally to the subwait and exam rooms. Typical area size is 100 sq. ft. (9.2 sq.M.).

80.343

The Darkroom houses film processing equipment where patient films are developed. A film pass-box is required. Typical room size is 80 sq. ft. (7.4 sq.M.).

80.344

An ARIA Workstation may be used as a Gateway to interface the Varian network software with the Customer's other computer systems.

80.345

A Passbox is recommended between the darkroom and the Acuity control equipment area.

80.346

A Garden or Atrium may be used to improve the patient treatment environment. The location of atria within treatment rooms requires the careful design of maze-like openings and must be reviewed by the Physicist of Record early in the design phase. Consider how the light level can be modified by the therapist for the low light level conditions required in the treatment room during patient set-up.

80.347

The Department Study shown on this drawing represents a typical installation only. This is not a construction document. Space for electrical and mechanical equipment is not shown. Refer to the "Equipment Information" Section for specific equipment facility requirements. Verify architectural design program requirements with the Customer.

80.348

Clinac medical linear accelerators are primarily used to treat cancer. They use high energy radiation to localize treatment on a tumor. Since concrete is a very economical material for radiation shielding, most designers use standard concrete as the primary shielding material.

When there are specific design criteria that limit the use of standard concrete, such as space limitations or regional economic consideration, other materials may be used to supplement or replace it. These materials include high density concrete, modular concrete or composite material blocks, lead, steel, polyethylene, paraffin and earth. As the use of any of these alternate materials requires a careful consideration of all radiation components, barrier design must be reviewed by a qualified radiation physicist early in the design phase.

In order to keep the entry door thickness as small as possible and to simplify utility access, most Clinac rooms have an entry maze corridor. This shields the door from direct exposure to the beam source. With thorough attention to door shielding design, patient safety and utility access, rooms may be constructed without a maze.

The larger vault shown here is sized to accommodate a Dual Energy Clinac (up to 20 MV). The required wall thicknesses for the Dual Energy Clinac vault will vary with the highest photon energy available. A typical room size for the Dual Energy Clinac is 1250 sq. ft. (116.1 sq.M.).

80.387

Acuity simulators duplicate the beam geometry of medical linear accelerators and are used during treatment planning to localize the treatment field. Since they use low level x-rays, Acuity rooms are usually constructed with conventional wall framing techniques and finished with lead lined drywall. Typical room size is 350 sq. ft. (32 sq.M.).

80.414

The smaller vault shown here is sized to accommodate a Low Energy Clinac (up to 6 MV). A typical room size for the Low Energy Clinac is 825 sq. ft. (76.6 sq.M.).

80.415

The Exam Rooms are used by the RTs and nursing staff to see patients for examination, consultation and treatment procedures. Typical room size is 90 sq. ft. (8.4 sq.M.).

80.550

The Clinac treatment room can function as a dual use room. The site will provide an Equipment Selector Switch for Clinac or Varisource, GammaMed operation.

80.585

The VariSource, GammaMed Room accommodates the VariSource, GammaMed HDR (High Dose Rate) Remote Afterloader. VariSource, GammaMed is used as one radiation treatment modality for cancer. This may be in conjunction to external radiation treatment with a linear accelerator or it may as the primary form of treatment. The VariSource, GammaMed room has radiation shielded walls constructed with approximately 15"(381) to 26"(660) of concrete, depending on clinical workload and adjacent occupancies, or an equivalent amount of other shielding materials. There is usually a small maze wall. This shields the door and utility penetrations from the radiation source. Proximity to the Acuity room is desirable. Typical room size is 450 sq. ft. (41.4 sq.M.).

VARIAN medical systems	[000] Refer to the Varian Components Chart at the end of this section.	Typical Department Plan			
	Not For Construction	Clinac/Acuity/VariSource/GammaMed/ARIA/Eclipse			
0.04.2 :page	planning dept.	© Varian Medical Systems 2008 All rights reserved.	31Mar08	revision: 5	doc. #: 862455 page: 0.04.2

80.586

Once the simulation has been completed, the patient begins daily treatments in the Clinac linear accelerator treatment room. These treatments can be scheduled for up to eight weeks or for as little as one week. The treatment itself, actual beam-on time, remains the same each day and typically lasts for 25-50 seconds. The larger the dose of radiation to be delivered, the longer the treatment time will be. The most time-consuming step in this process is the setup. The treatment setup must reproduce the simulation process as closely as possible. Setup times vary for each patient and the complexity of their treatment. A lung patient is much easier to setup than a TBI (total body irradiation). Accurate setup is accomplished through the use of the ODI (optical distance indicators), laser positioning lights and patient markings. ODI numbers are projected from the gantry head. Each day the patient is set up precisely the same way, resulting in the patient being in the same position to receive treatments. Most centers schedule patients at ten or fifteen minute intervals. Some treatments, such as TBI or stereotactic radiotherapy, can take one hour or more to setup and treat. Below is an outline of a typical treatment procedure:

1. The Patient arrives and, if needed, changes into a hospital gown.
2. The Patient is brought into the room and the Therapist explains what will be happening during the next fifteen minutes.
3. The Patient gets onto the treatment couch and is moved vertically and longitudinally into the gantry area.
4. The Therapist turns off the lights and uses the ODI and lasers to setup to the patient's treatment marks.
5. At this point the Therapist might take a port film. A port film is a verification film of the intended treatment area. The Physician will check this against the simulation film and approve it for treatment.
6. Once the film has been approved, the treatment will start. The Patient will hear the machine producing the radiation, but will not feel anything unusual and can breath normally during the treatment.
7. Once the treatment is completed the Patient will leave the department and return the following day for the next treatment.

80.587

The Acuity simulator is used after the Patient has a series of diagnostic tests and radiation therapy has been chosen as the selected treatment method. The Radiation Oncologist, with the aid of the Radiation Therapist, will mark out the area that needs to be treated. The simulator is used:

- to position i.e. localize the treatment fields (that will be used to treat the patients tumor)
- verify planned field positions that have to be localized using CT data
- Check for patient movement – especially when using conformal therapy
- re simulate patients who have started treatment but may have found that the set up does not fit as the patient may have lost weight.

This is all done utilizing radiographic and fluoroscopic imaging to acquire reference images at the proposed treatment field position. The treatment field will be duplicated on a daily basis in the treatment room. The simulation process typically takes between thirty minutes and two hours depending how much planning has been performed prior to simulation. During the simulation, the Patient remains very still for prolonged periods. Below is an outline of a typical simulation procedure:

1. The Patient is brought into the room and the Therapist explains the simulation procedures to be followed during the next hour.
2. The Patient gets, or is assisted, onto the table.
3. The Therapist moves the simulator couch into position under the gantry head.
4. The Therapist takes the necessary patient separations to get an approximate distance from isocenter to the tumor that needs to be located. This may be done through the use of calipers or lasers.
5. The main room lights are turned off and the Patient is placed in position. Set up marks are put on the patient to use during treatment.
6. The Physician and Therapist will fluoroscopically image the intended treatment area. This process will last a few minutes where changes to the field position may be made on the basis of the image information viewed.
7. Once the field position is correct the Therapist may then take a simulation film or save the digital image as a reference image. The field position will be marked on the patient's skin.
8. A simulation film or digital image will be acquired in order to confirm and record the treatment area. The exposure time necessary to get an image in film is only a matter of seconds. The fluoroscopy time and number of films and exposures used for that patient will be recorded for dose purposes.

VARIAN medical systems	[000] Refer to the Varian Components Chart at the end of this section.	Typical Department Plan			
	Not For Construction	Clinac/Acuity/VariSource/GammaMed/ARIA/Eclipse			
0.04.3 :page	planning dept.	© Varian Medical Systems 2008 All rights reserved.	31Mar08	revision: 5	doc. #: 862455 page: 0.04.3

80.588

The VariSource, GammaMed Remote Afterloader delivers high radiation doses to patients by way of a radioactive source wire that is extended through catheter(s) into body cavities into or near the tumor. Some tumors require placement of needle(s) directly into the tumor site if a cavity is not near. The needle is then attached to the catheter for treatment. The source wire is stored in a safe until it is extended for treatment via the catheter into the patient to the tumor site. The treatment is computer-controlled from a remote control area. The Patient may be treated in a single session or in several sessions. A typical treatment takes ten to twenty minutes. Patients may or may not be required to be hospitalized during treatment. Below is an outline of a typical clinical procedure:

1. A typical treatment with the Afterloader starts with the placement of the catheter(s) into the Patient's body cavity, i.e. the trachea and into the bronchus for lung cancer, or placement of needle(s) directly into the tumor area. This is normally performed by a doctor (of appropriate specialty, i.e. Internist, Surgeon, Gynecologist) in a sterile environment, not normally the Afterloader treatment room.
2. The Patient is moved to the radiation therapy department to the simulator and is positioned on the simulator couch in the treatment position.
3. The Radiation Oncologist inserts a radio-opaque marker wire into the catheter(s) or needle(s).
4. The Therapist takes several diagnostic images (x-ray films /CT/ ultrasound) of the marker wires. The marker wires are removed.
5. The Patient leaves the diagnostic imaging room with the catheter(s) or needle(s) still in position and waits either in his/her hospital room or a special waiting area in the radiation therapy department.
6. The Radiation Oncologist prescribes the necessary treatment dose.
7. The Physicist or Dosimetrist digitizes data points from the diagnostic images and calculates a treatment plan using the VariSource, GammaMed treatment planning computer. Treatment data containing source positions and time is copied onto a floppy disk. The treatment planning computer is normally located in the treatment planning or physics area of the department.
8. The floppy disk is taken to the VariSource, GammaMed control console and the treatment plan is transferred. For the GammaMed system, there is an additional option of transferring the treatment file via network connection, as both the treatment planning computer and the control console computer are able to networked.
9. The Therapist or Radiation Oncologist moves the Patient into the VariSource, GammaMed treatment room.
10. The Patient is positioned on a treatment bed or gurney in the proper treatment position.
11. The Patient, with the catheter or needle attached, is connected to the Afterloader.
12. The Therapist or Radiation Oncologist leaves the treatment room and shuts the door.
13. The Therapist or Radiation Oncologist starts the treatment by activating commands on the control console. The radioactive source wire will extend into the catheter inside the Patient, stopping at the tumor site to deliver the treatment.
14. The Therapist or Radiation Oncologist monitors the patient on a CCTV system and the progress of the treatment at the console area monitor.
15. When the treatment is completed, the Patient is detached from the VariSource, GammaMed, and if no further treatments are necessary, the catheter(s) or needle(s) are removed by the doctor who placed them.

80.647

The ARIA product is a complete oncology department information management system. Its made up of a suite of software application modules that reside on computer workstations throughout the department and other remote facilities via wide area networks. Workstations are connected over a network to centrally located computer servers where the data is stored. The size and configuration of the system is widely variable. It can range from a very small networked system that has 4 workstations and 1 server to 100 workstations and 3-4 servers. The Varian provided ARIA software applications are all Windows client/server compliant meaning they will operate with Intel class personal computers (PCs) on a network. Customers have the option to provide the PC computers providing they meet Varian's recommendations. Network infrastructure is generally provided and setup for ARIA either by the hospital IS department or through hospital networking contractors.

The design team should review the purchase order with the customer and verify the number of workstations they expect to be available for department use. Show the supporting architecture as described in this IDP.

	[000] Refer to the Varian Components Chart at the end of this section.	Typical Department Plan			
	Not For Construction	Clinac/Acuity/VariSource/GammaMed/ARIA/Eclipse			
0.04.4 :page	planning dept.	© Varian Medical Systems 2008 All rights reserved.	31Mar08	revision: 5	doc. #: 862455 page: 0.04.4

80.653

Eclipse is a comprehensive treatment planning system that plans for all modalities such as IRREG, 3D conformal, intensity-modulated radiation therapy (IMRT), electron, proton and brachytherapy. Eclipse supports advanced processes such as image-guided radiation therapy (IGRT) and dynamic adaptive radiation therapy (DART). The treatment planning process typically involves several steps including target volume delineation, critical structure segmentation, dose prescription, treatment field parameter definition, calculation of dose distributions and evaluation and approval. The team members involved with these steps include the radiation oncologist, medical physicist, dosimetrist and therapist.

A typical treatment planning procedure is as follows:

1. Patient Image Acquisition (3D): A computerized treatment planning procedure begins with a model of the patient anatomy. Eclipse can create 3D patient models from any DICOM 3.0 compliant image data sets including CT, MR and PET. Ensure that one of the following methods is available for importing DICOM image data into Eclipse:

- a. Network connection to CT / MRI (most common)
- b. Film laser scanning system

2. Patient Image Acquisition (2D): Occasionally, the patient model is entered manually by tracing the body, internal structures and target. Treatment planning would then be done on this manually-created patient model. During simulation, X-ray images may be printed on film or acquired electronically. These images could be used to define treatment field apertures. The doctor may draw the apertures directly on the film which would then be scanned or digitized into Eclipse for further planning. If the X-ray images were acquired electronically, these images could be sent to Eclipse, where the treatment field aperture would be defined. If the patient model or field aperture is going to be manually digitized into Eclipse, ensure that the following is available:

- a. Film digitizer tablet system

Ensure that one of the following methods is available for importing acquired X-ray images into Eclipse:

- a. Network connection to conventional Acuity simulator
- b. Film laser scanning system

3. After the dose distribution is calculated, the treatment plan and the dose distribution may be printed for physician review. These printed documents would be used as part of the patient's permanent treatment record. Within the image management environment, all image data, such as setup field reference images (DRRs), can be transmitted across the network to anywhere in the department; for example, the treatment machine. In a non-image management environment it may be necessary to print digitally reconstructed radiograph (DRR) images onto paper or film. Ensure that the appropriate printer is located in or near the treatment planning area:

- a. 11"x17" Color printer / plotter
- b. Film laser printer

4. Treatment planning parameters must be transferred to the treatment machine either through the record and verify system or through proper documentation. As part of a treatment plan, field apertures may be defined by a multileaf collimator or poured cerrobend blocks. Ensure that the following interfaces and equipment are available and configured to accept treatment planning data:

- a. Network connected to a Record and Verify system
- b. MLC is installed and commissioned
- c. Block-cutter interface that accepts DICOM plan files from Eclipse
- d. Network printer

	[000] Refer to the Varian Components Chart at the end of this section.	Typical Department Plan			
	Not For Construction	Clinac/Acuity/VariSource/GammaMed/ARIA/Eclipse			
0.04.5	:page planning dept.	© Varian Medical Systems 2008 All rights reserved.	31Mar08	revision: 5	doc. #: 862455 page: 0.04.5

Primary Barrier	4 MV	6 MV	8 MV	10 MV	15 MV	18 MV	20 MV
At 100% occupancy	66 (1676)	75 (1905)	84 (2134)	86 (2184)	91 (2311)	93 (2362)	96 (2438)
At 10% occupancy	53 (1346)	62 (1575)	70 (1778)	72 (1829)	75 (1905)	78 (1981)	80 (2032)
Secondary Barrier							
At 100% occupancy	30 (762)	33 (838)	39 (991)	40 (1016)	43 (1092)	43 (1092)	44 (1118)
At 10% occupancy	21 (534)	22 (559)	27 (686)	28 (711)	30 (762)	31 (788)	32 (813)

Inches (mm) of 147 lbs/cu ft (2355 kg/cu M) Concrete

Typical Shielding for Standard Procedures

[70.105](#) [70.153](#) [70.373](#) [71.108](#)

Secondary Barrier	4 MV	6 MV	8 MV	10 MV	15 MV	18 MV	20 MV
At 100% occupancy	34 (863)	37 (940)	42 (1067)	43 (1092)	47 (1194)	47 (1194)	48 (1219)
At 10% occupancy	24 (610)	26 (660)	31 (787)	32 (813)	34 (864)	35 (889)	36 (914)

Inches (mm) of 147 lbs/cu ft (2355 kg/cu M) Concrete

Typical Shielding for Standard Procedures with 50% IMRT of a Factor F=3

[70.153](#) [70.373](#) [70.105](#) [71.108](#)

Primary Barrier	6 MV	10 MV
At 100% occupancy	81 (2057)	92 (2337)
At 10% occupancy	68 (1727)	77 (1956)
Secondary Barrier		
At 100% occupancy	40 (1016)	46 (1168)
At 10% occupancy	29 (737)	35 (889)

Inches (mm) of 147 lbs/cu ft (2355 kg/cu M) Concrete

Typical Shielding for SRS Procedures with 20% IMRT of a Factor F=3

[70.105](#) [70.153](#) [70.373](#) [71.108](#)

		4 MV	6 MV	8 MV	10 MV	15 MV	18 MV	20 MV
Steel	Primary Barrier	3.2	3.5	3.5	3.7	4.0	4.0	4.1
	Secondary Barrier	3.2	3.5	3.6	3.6	3.8	3.8	3.9
Lead	Primary Barrier	5.4	6.2	6.4	7.0	7.6	8.0	8.3
	Secondary Barrier	5.4	6.2	6.3	6.6	7.0	7.0	7.0

Inches (mm) of 147 lbs/cu ft (2355 kg/cu M) Concrete Equal to One Inch (mm) of Lead/Steel

Concrete to Lead and Steel Ratios

[70.153](#) [70.371](#)

	4 MV	6 MV	8 MV	10 MV	15 MV	18 MV	20 MV
Primary Beam X-Rays	11.4 (240)	13.5 (343)	14.3 (363)	15.3 (389)	17.0 (432)	17.5 (455)	18.0 (457)
Leakage X-Rays (90°)	10.0 (254)	11.0 (279)	11.5 (292)	12.0 (305)	13.0 (330)	13.0 (330)	13.5 (343)

Inches (mm) of 147 lbs/cu ft (2355 kg/cu M) Concrete

Tenth Value Layer (TVL) for Concrete vs X-Ray Energy

[70.372](#)

	4 MV	6 MV	8 MV	10 MV	15 MV	18 MV	20 MV
Lead	1/8 (3)	1/8 (3)	1/4 (6)	1/4 (6)	n/a	n/a	n/a
Wood	2 (51)	2 (51)	3 (76)	3 (76)	n/a	n/a	n/a
Lead	n/a	n/a	n/a	n/a	1/4 (6)	3/4 (19)	3/4 (19)
5% Borated Polyethylene	n/a	n/a	n/a	n/a	3 (76)	4 (102)	5 (127)
Steel—Both Sides	n/a	n/a	n/a	n/a	1/4 (6)	1/4 (6)	1/4 (6)



Thickness in Inches (mm)

Typical Minimum Clinac Room Door Shielding

[70.106](#) [70.121](#) [70.438](#)

A Typical Room Shielding Tables [70.446](#) [70.515](#) [10.180](#)

IDP1001

	 Refer to the Varian Components chart at the end of this section.	Typical Room Shielding Tables Clinac Linear Accelerators				
	Not For Construction					
1.21.0 :page	planning dept.	© Varian Medical Systems 2008 All rights reserved.	30Jun09	revision: 4	doc. #: 1100728	page: 1.21.0

10 - General Notes

10.180

The information shown is for ALL Clinac linear accelerator models 2100C(D), 2300C(D), 21EX, 23EX, iX, Trilogy and Novalis Tx.

70 - Radiation Shielding

70.105

Treatment room shielding is required for the protection of therapists and others while the Clinac has the beam on. Clinac shielding is provided by either poured-in-place concrete alone (low or dual x-ray energy), lead/steel plates alone (low x-ray energy only), or a prescribed combination of both (low or dual x-ray energy).

70.106

The amount and type of shielding on treatment room entrance doors have varying requirements based on the presence and length of the maze, and the energy of the Clinac. Generally, low energy Clinacs will require wood doors with a lead core and manual operation. Dual Energy Clinacs usually require steel doors with a lead and borated polyethylene core and motorized operation. Exact Clinac door shielding requirements are dependent on maze and shielding configuration. See typical minimum suggested door shielding. Clinac neutron leakage calculations down the maze follow the general guidelines of NCRP Report 79. A Varian monograph titled: "Neutron Doors for High Energy Accelerators", is available on request. As these doors do not have latching mechanisms, room air pressure must be positive relative to the department. Typically, shielded doors must be "exempted" where fire code labeling is required.

70.121

To reduce radiation exposure outside room, air handling ducts should enter/exit the room through penetration(s) above the maze door. The ducts should be placed as high as possible in order to minimize radiation exposure to occupied space. The ducts should be designed to minimize the area of penetration through the wall. In most cases, duct shielding will not be required, provided the duct design conforms to this criteria. Clear space should be left around the duct (outside the treatment room) for shielding retrofit, in case the post installation radiation survey indicates a requirement. Penetration, including ducts, directly into the treatment room should be avoided. For no-maze treatment rooms, duct design and shielding must be addressed by the Physicist of Record.

70.153

Provide adequate radiation shielding (usually lead or steel with a 1"(25) margin) behind all junction and pull boxes recessed in concrete walls. Verify thickness and location with the Physicist of Record.

70.371

Steel or lead shielding at Clinac rooms may be embedded in or mounted on the inside surface of concrete walls and ceiling. Additional structural reinforcement may be required. Neutron shielding must be carefully analyzed by the Physicist of Record when lead or steel is to be located on primary or secondary barriers on installations with photon energies higher than 10 MV.

70.372

Clinac shielding calculations follow the general guidelines of NCRP Reports 49 and 51. The TVL of leakage x-rays have been modified based on the report of W.R. Nelson and P.D. LaRiviere: "Primary and leakage Radiation Calculations at 6, 10 and 25 MeV", Health Physics, 38811 (1984). Copies are available on request. Except where specifically noted, radiation leakage in noncontrolled areas shall not exceed 2 mrem/week (20 uSv/week), assuming 100% occupancy beyond the shielding barriers (per NCRP Report 91 "Recommendations of Limits for Exposure to Ionizing Radiation").

70.373

The shielding table suggestions are based on calculations using NCRP report 151 methodology and measured data. Distances of point of interest from isocenter are taken from the Varian's "Typical Room Configuration" in the equipment information section of the IDP. The room dimensions are based on machine clearance. This would translate into a distance of 10 feet from the isocenter to the nearest inner wall surface of the primary barrier.

- > The primary beam use factor is defined as 25%.
- > The occupancy is defined as either 100% or 10%.
- > The weekly dose limit is defined as 2 mrem (20 Sv/week).

>The workload for standard procedures is defined as 75000 rads/week of which

System used for 10 hrs per day, 5 days per week, 5 patients treated per hour at 250 rads per session

W = 75,000 rads per week for primary walls

W = 75,000 rads per week for secondary walls

>The workload for standard procedures with 50% IMRT procedures and a modulation factor of F=3.

W = 75,000 rads per week for primary walls

W = 150,000 rads per week for secondary walls

> The workload for SRS procedures in high dose rate mode (dose rates > 1000 MU/min) is defined as 200,000 rads/week with 20% IMRT procedures and a modulation factor of F=3.

System used for 10 hrs per day, 5 days per week, 2 treatments per hour at 2000 rads per treatment, average 6 sessions per day.

W = 200,000 rads per week for the primary walls.

W = 280,000 rads per week for the secondary walls.

The dose output in the high dose rate mode is assumed to be 1500 rads/min for the 6X and 3000 rads/min for 10X.

70.438

Most treatment rooms are entered through a maze. This hallway is designed to reduce radiation levels at the entrance door. The length of the maze and the occupancy outside the entrance door affects the amount of shielding required in the door. "No-maze" doors are available from several shielding manufacturers. The use of these doors must be reviewed by the Physicist of Record early in the design process.

70.446

Supplement No. 11 (1972) and Supplement No. 17 (1983) of the "British Journal of Radiology" describes two different conventions for referencing the quality of an x-ray radiotherapy beam. The convention presented in Supplement No. 11 has been adopted for this information sheet.

BJR 11 value - (MV) 4 6 8 10 15 18 20

BJR 17 value - (MV) 4 6 8 10 16 23 25

70.515

The Typical Room Shielding Tables information is provided to assist early treatment room design. The Physicist of Record for the project should become involved with the treatment room design as early as possible. With regard to facility shielding, the Physicist of Record is responsible for designing the treatment room radiation shield barriers and confirming they meet applicable regulatory requirements. The facility design is based on regulatory requirements of the regulatory body tasked with oversight of Radiation Producing Devices in the Region, and recommendations of the National Council of Radiation Protection and Measurement (NCRP).

Varian will have no approval or other responsibility for any matter affecting or related to the adequacy of the radiation protection walls and barriers or related safety devices. The radiation shielding must be approved by the Customer's Physicist of Record and shall be the Customer's sole responsibility.

71 - Other Shielding

	[000] Refer to the Varian Components Chart at the end of this section.	Typical Room Shielding Tables Clinac Linear Accelerators				
	Not For Construction					
1.21.1 :page	planning dept.	© Varian Medical Systems 2008 All rights reserved.	30Jun09	revision: 4	doc. #: 1100728	page: 1.21.1

71.108

For siting a Clinac or Acuity, and their associated video monitors, consideration should be taken of the proximity to Magnetic Resonance Imaging (MRI) units or other magnetic field generating equipment. According to MRI manufacturers, linear accelerators and simulators should be located outside of the 1 Gauss magnetic field line created by the MRI. A map of the magnetic field emanating from the particular MRI unit can be obtained from the manufacturer of the MRI unit.

	[000] Refer to the Varian Components Chart at the end of this section.	Typical Room Shielding Tables Clinac Linear Accelerators			
	Not For Construction				
1.21.2 :page	planning dept.	© Varian Medical Systems 2008 All rights reserved.	30Jun09	revision: 4	doc. #: 1100728 page: 1.21.2

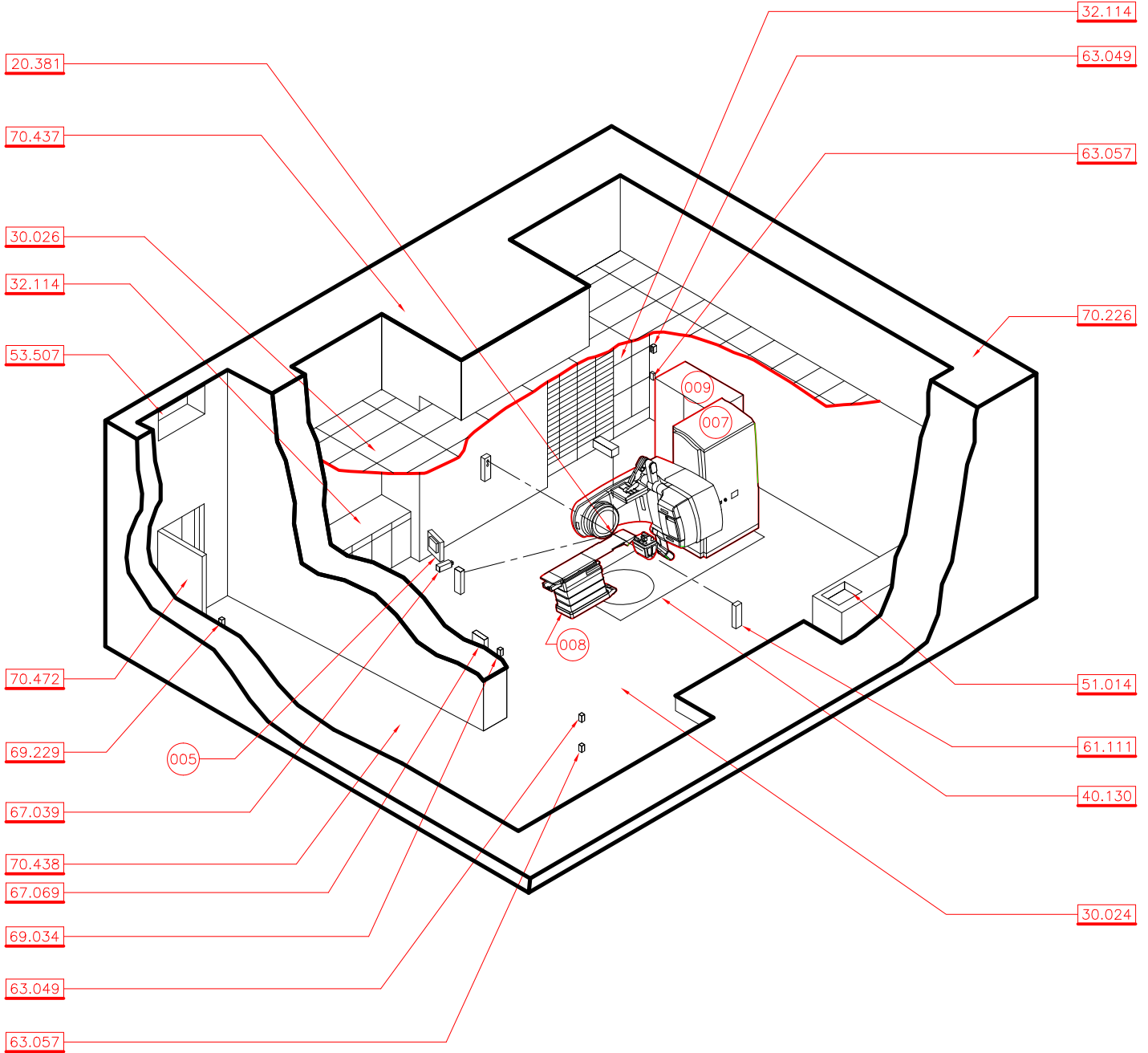

A Typical Room Isometric 10.124

IDP1002

	000 Refer to the Varian Components chart at the end of this section.	Typical Room Isometric View Clinac Linear Accelerators				
	Not For Construction					
1.22.0 :page	planning dept.	© Varian Medical Systems 2008 All rights reserved.	31Mar08	revision: 5	doc. #: 1100730	page: 1.22.0

10 - General Notes

10.124

The layouts shown on IDP drawings represent typical plans only. Clearances and wall thickness may vary.

10.180

The information shown is for ALL Clinac linear accelerator models 2100C/D), 2300C/D, 21EX, 23EX, iX, Trilog and Novalis Tx.

20 - General Layout Notes

20.381

Isocenter - This is the primary reference point for Varian equipment. Show the isocenter location clearly on all relevant drawings. Maintain the isocenter location on site by extending perpendicular axis lines along slab and up walls in all four directions. The isocenter heights for Clinac Linear Accelerator and Silhouette are as follows:

- > Standard Isocenter Height - 4'-3" (1295)
- > Optional lowered Isocenter - 4'-1" (1245)

30 - Finishes

30.024

As with most computer components, the electronic components for this equipment are sensitive to localized static electricity. Carpeting or other flooring adjacent to the equipment in the room or at the control equipment area should not exceed a 2.0 kV rating at 20% relative humidity when measured as outlined by the methods in AATCC-134. Retrofit static dissipative coatings are also available from various manufacturers. Carpet, while otherwise advantageous, can make gurney movement difficult. Floor stains are common due to the use of dyes to mark reference points on patients. Many facilities use carpet squares that can be replaced or cleaned and allow access to floor duct if used.

30.026

Exposed grid ceilings allow for access to the overhead laser and relay junction box without the use of access doors. Major service at the equipment Stand is simplified where there are removable ceiling tiles. Coordinate the layout of ceiling tile to insure that ceiling support system shall not interfere with overhead laser positioning light beam port.

32 - Room Storage Casework

32.114

Bulk and shelf storage are required for Varian accessories and various materials used for therapy. The Varian-supplied Accessories include Electron Applicators (cones), Wedges, and other field-defining devices. Storage space in the treatment room should be planned to reduce travel required for patient set-up. Patient block tray storage should be located on the entrance side of the Treatment Couch. Linen storage in the treatment room and storage space for many patient positioning pads and devices is desirable.

40 - Base Frame Installation / Anchorage

40.130

This is the out line of Base Frame pit recess.

51 - Plumbing

51.014

A sink with running hot and cold water is highly recommended in Clinac rooms. Appropriate codes should be followed regarding paddle or foot controls and type of faucet. A hose spigot is necessary to fill the water phantom and a drain is necessary to service the Clinac's internal cooling system and drain the water phantom. Floor drains and floor sinks should not be located in the room to avoid possible backup into the equipment floor recesses. Do not run water lines directly above the Clinac components or control console.

53 - Ventilation

53.507

To reduce radiation exposure outside room, air handling ducts should enter/exit the room through penetration(s) above the maze door.

61 - Laser Positioning Lights

61.111

The patient's position on the Couch is fixed by body markings that are aligned with "cross hairs" cast by the laser lights. Two wall laser positioning lights at isocenter height, a ceiling laser and the sagittal laser are powered by a common circuit controlled via the user interface in the Control Room or Couch Pendant or Couch Side Panels, through a relay. Lasers are usually distributed and installed, at the Customer's option, by Varian. The Customer is responsible for verification of laser types and mounting configurations.

63 - Safety Device Systems

63.049

Provide beam-on warning lights in the treatment room, and over the door, or at eye level adjacent to the door outside the treatment room. Colored (usually red) lights usually must be placed such that one is visible from any point in a Clinac room. They are usually located adjacent to the emergency-off switches. They indicate beam-on condition and may be required to blink when the beam is on. Verify local requirements with regional regulatory agencies.

63.057

Provide emergency-off switches in room (normally closed type, manual reset). In addition to the switches required as part of the room, emergency-off devices are built into the Clinac Stand and Couch, Console and at the Clinac Modulator. Adequate switches must be provided in Clinac rooms so that one need not pass through the primary beam to disable the Clinac. Do not locate emergency-off switches in primary beam. Locate switches to avoid inadvertent contact, such as by gurneys or carts. Verify all requirements with regional regulatory agencies.

67 - Communications

67.039

Provide one or two CCTV cameras in the room. The CCTV cameras are usually located approximately 15 degrees off each side of the equipment's longitudinal axis. Consult with the Customer for desired location. Provide a power receptacle and signal conduit from the control equipment area at each camera. Do not locate cameras in the primary beam path. Refer to the CCTV System manufacturer's literature for conduit, mounting and installation requirements.

67.069

Provide a two-way patient monitoring intercom system. The in-room intercom may be wall and/or ceiling mounted and should be voice-activated or continuous-on. The intercom at the control equipment area should be push-to-talk. Provide a signal conduit from the control equipment area and power to the intercom. Refer to the intercom manufacturer's literature for conduit, mounting and installation requirements. A non-interruptible power source may be required by regulatory code.

69 - Power Receptacles / Switches

69.034

Provide a dimmer switch for set-up lights. This switch is used to adjust the illumination level of the set-up lights so that they are dim enough for clear visibility of the lasers, but bright enough for safe movement through the room.

69.229

Door operator switches are required for Clinac installations with motorized doors. The in-room switch is typically located near the inside of the door. The outer switch should be located near, and in control of, the control equipment area. Provide electrical power for the door operator and coordinate the vault ceiling height at the door to clear the door operator hardware. Verify details with the door manufacturer.

70 - Radiation Shielding

70.226

This is the secondary shielding.

	[000] Refer to the Varian Components Chart at the end of this section.	Typical Room Isometric View Clinac Linear Accelerators			
	Not For Construction				
1.22.1 :page	© Varian Medical Systems 2008 All rights reserved.	31Mar08	revision: 5	doc. #: 1100730	page: 1.22.1

70.437

This is the primary beam shielding.

70.438

Most treatment rooms are entered through a maze. This hallway is designed to reduce radiation levels at the entrance door. The length of the maze and the occupancy outside the entrance door affects the amount of shielding required in the door. "No-maze" doors are available from several shielding manufacturers. The use of these doors must be reviewed by the Physicist of Record early in the design process.

70.472

Provide a radiation shielded door.

	[000] Refer to the Varian Components Chart at the end of this section.	Typical Room Isometric View Clinac Linear Accelerators				
	Not For Construction					
1.22.2 :page	planning dept.	© Varian Medical Systems 2008 All rights reserved.	31Mar08	revision: 5	doc. #: 1100730	page: 1.22.2

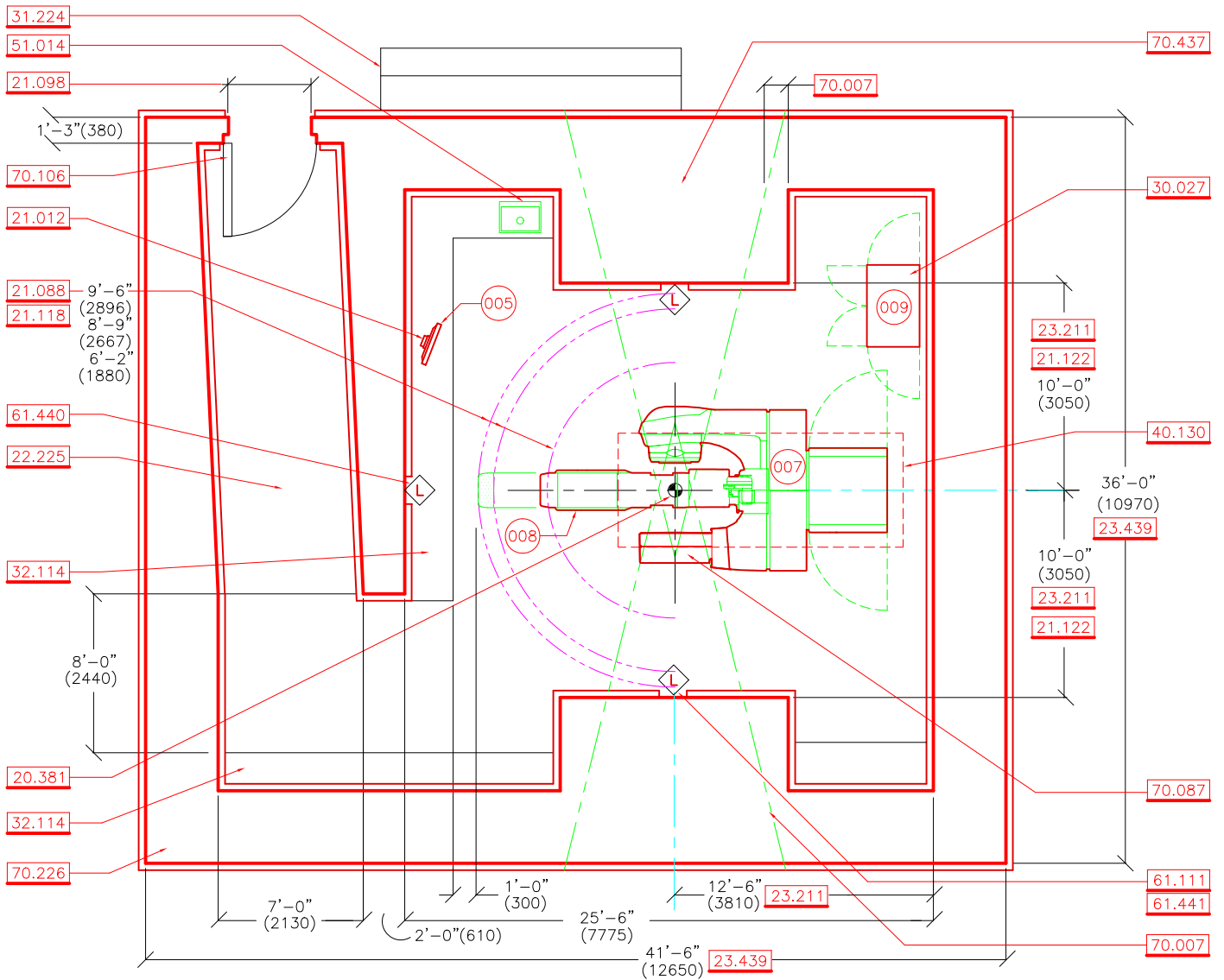

B Typical Room Plan View 10.124 30.380

IDP1004

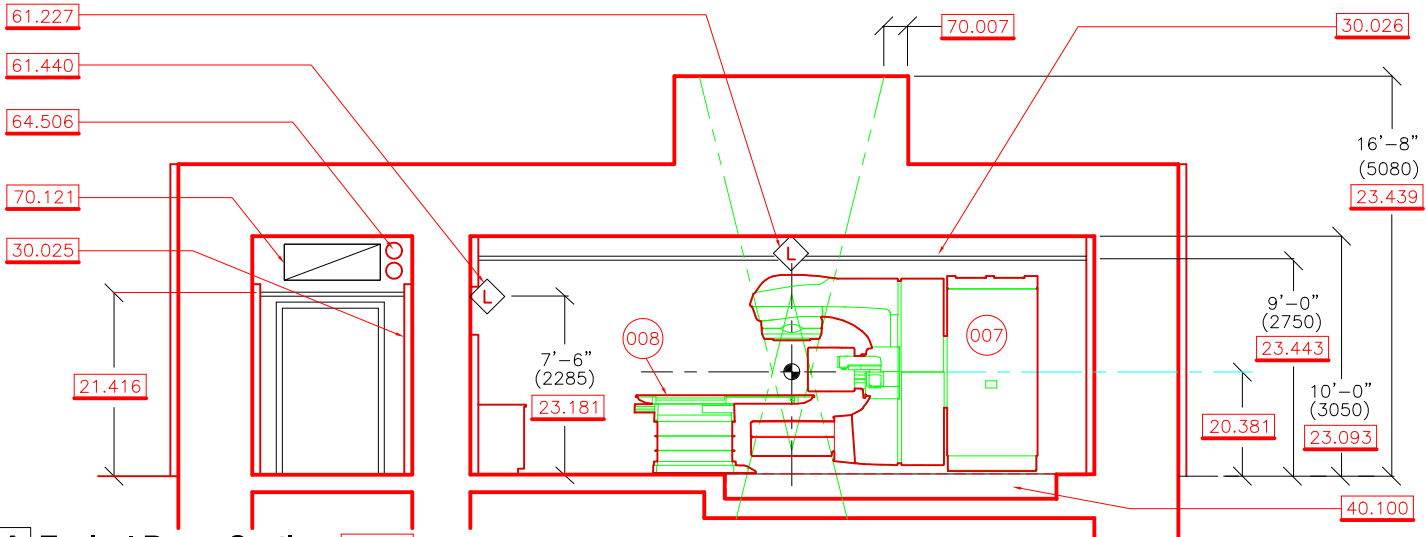

A Typical Room Section 10.124

IDP1003

scale at:	1 = 100	0	2	4	6	8	10	12
	1/8"=1'-0"	0	2	4	6	8	10	12
VARIAN medical systems	(000) Refer to the Varian Components chart at the end of this section. Not For Construction							
1.23.0 :page				planning dept.				© Varian Medical Systems 2008 All rights reserved.
23Jan09		revision: 7		doc. #: 861626		page: 1.23.0		

**Typical Room Configuration
Clinac Linear Accelerators**

10 - General Notes

10.124

The layouts shown on IDP drawings represent typical plans only. Clearances and wall thickness may vary.

10.180

The information shown is for ALL Clinac linear accelerator models 2100C/D), 2300C/D, 21EX, 23EX, iX, Trilog and Novalis Tx.

20 - General Layout Notes

20.381

Isocenter - This is the primary reference point for Varian equipment. Show the isocenter location clearly on all relevant drawings. Maintain the isocenter location on site by extending perpendicular axis lines along slab and up walls in all four directions. The isocenter heights for Clinac Linear Accelerator and Silhouette are as follows:

- > Standard Isocenter Height - 4'-3" (1295)
- > Optional lowered Isocenter - 4'-1" (1245)

21 - Equipment Layout / Clearances

21.012

The In-Room Monitor should be located where the operator can observe it without turning away from either the machine or patient on the couch. The monitor provides information during patient setup and it is unsafe to turn away from the patient while the machine is moving and the patient is on the couch. The In-Room Monitor may be mounted on a wall, ceiling, or shelf. Do not locate the In-Room Monitor in the primary beam path.

21.088

The recommended couch arc clearance allows complete rotation of the Couch at its maximum radius (retracted). Clearance that allows complete rotation of the Couch at its minimum radius, but with some obstruction of the maximum radius is acceptable, but must be reviewed by the Customer for specific clinical requirements. In specific situations, such as dynamic stereotactic treatment, a larger area may be required. Generally, the inability to rotate the Couch completely in its minimum position is unacceptable.

21.098

Provide a minimum 4'-0"(1220) clear by 7'-0"(2135) opening for equipment clearance at radiation shielded entrance doors to treatment rooms. This clearance allows proper access for rigging Varian equipment.

21.118

The Exact Treatment Couch 008 is standard with the Clinacs. The maximum Couch arc clearance is 9'-6"(2896). The maximum Couch arc clearance with Extension Panel removed is 8'-9"(2667). The minimum Couch arc clearance is 6'-2"(1880).

21.122

Approximately 16'-6"(5000) isocenter to wall distance may be required at one side of Couch for total body irradiation. Consult with Customer.

21.416

The ceiling height recommendation shown at the equipment applies to the area over the Clinac Stand and Gantry. The ceiling height may be lowered as desired in the remainder of the room and maze.

22 - Rigging

22.225

Verify adequate equipment access into room and around maze.

23 - Dimension Descriptions

23.093

This is the recommended minimum dimension to concrete above. This dimension allows minimum clearance for laser and utilities above ceiling.

23.181

This is the recommended height above the finish floor.

23.211

This is the recommended dimension to concrete. Recommended face of concrete dimensions assume up to 6"(150) of wall furring.

23.439

This dimension is provided for planning purposes only. Actual dimensions will vary with shielding requirements and construction practices.

23.443

This is the recommended minimum clear dimension to the ceiling over the equipment Stand and Gantry.

30 - Finishes

30.025

Wall finish requirements and regulations vary between jurisdictions. Many architects reduce the institutional aspects of the simulation and treatment rooms with wood paneling or wall covering, carpeting, photo murals, plants, skylights and atria. Cleaning and sanitation should be considered. Corner and wall guards are highly recommended for protection from gurneys and carts. Most facilities cover the concrete walls of the treatment room vault with drywall furring. This allows conduit and piping to be surface-mounted to the concrete. The typical thickness at the side and front walls is 4"(100) to allow the laser positioning lights to be fully recessed.

30.026

Exposed grid ceilings allow for access to the overhead laser and Relay Junction Box without the use of access doors. Major service at the equipment Stand is simplified where there are removable ceiling tiles. Coordinate the layout of ceiling tile to insure that ceiling support system shall not interfere with overhead laser positioning light beam port.

30.027

There are no recognized acoustical standards for therapy rooms. The primary sound source on dual energy Clinac systems is the Modulator Cabinet. Varian has met no acoustical problems when the Modulator is located in the treatment room. The patients are in the room for a very short time and some seem reassured by the changing sound levels as the machine goes through its cycles. Noise is a concern, however, when the Modulator Cabinet is located next to therapists or others who are exposed to it often. Placing the Modulator in a nearby closet is acceptable. Consult with the Customer regarding preferred location. The use of acoustically absorbent materials is recommended.

30.380

A separation wall can be installed by the Customer between the Clinac Stand and Gantry. While not usually recommended by Varian, this type of layout provides additional storage area and creates an acoustic barrier between the primary noise producing components and the patient. Since the primary heat sources are placed behind the partition, this area must be adequately ventilated. Factors of this design to consider include the perceptual implications of the decreased room size, increased construction time and additional cost. This partition must be carefully designed to provide for service access and installed after the equipment installation is complete. Suggested design drawings are available from the Planning Department.

31 - Control Equipment Casework

31.224

Control equipment casework.

32 - Room Storage Casework

32.114

Bulk and shelf storage are required for Varian accessories and various materials used for therapy. The Varian-supplied Accessories include Electron Applicators (cones), Wedges, and other field-defining devices. Storage space in the treatment room should be planned to reduce travel required for patient set-up. Patient block tray storage should be located on the entrance side of the Treatment Couch. Linen storage in the treatment room and storage space for many patient positioning pads and devices is desirable.

40 - Base Frame Installation / Anchorage

	[000] Refer to the Varian Components Chart at the end of this section.	Typical Room Configuration Clinac Linear Accelerators				
	Not For Construction					
1.23.1 :page	planning dept.	© Varian Medical Systems 2008 All rights reserved.	23Jan09	revision: 7	doc. #: 861626	page: 1.23.1

40.100

A steel frame is used to anchor the Clinac Stand, Gantry and Couch to the facility. The frame is set in a recessed equipment pit, leveled (by Varian), and held in place with grout. Base Frames are positively anchored to the slab to avoid floating during grout placement. Verify anchorage details with your Installation Project Manager office. Varian information regarding pit design assumes a ground floor installation. Upper floor installations require a thorough review by a qualified structural engineer. In typical installations, Base Frames for Clinacs are not positively anchored sufficiently to accommodate seismic loads. All seismic anchoring is by the Customer. Sample seismic calculations and details of the preferred anchoring methods for Clinacs are available from the Planning Department.

40.130

This is the out line of Base Frame pit recess.

51 - Plumbing**51.014**

A sink with running hot and cold water is highly recommended in Clinac rooms. Appropriate codes should be followed regarding paddle or foot controls and type of faucet. A hose spigot is necessary to fill the water phantom and a drain is necessary to service the Clinac's internal cooling system and drain the water phantom. Floor drains and floor sinks should not be located in the room to avoid possible backup into the equipment floor recesses. Do not run water lines directly above the Clinac components or control console.

61 - Laser Positioning Lights**61.111**

The patient's position on the Couch is fixed by body markings that are aligned with "cross hairs" cast by the laser lights. Two wall laser positioning lights at isocenter height, a ceiling laser and the sagittal laser are powered by a common circuit controlled via the user interface in the Control Room or Couch Pendant or Couch Side Panels, through a relay. Lasers are usually distributed and installed, at the Customer's option, by Varian. The Customer is responsible for verification of laser types and mounting configurations.

61.227

The overhead laser positioning light is located directly over the isocenter.

61.440

The sagittal laser positioning light is located on the wall at the end of the longitudinal couch axis. Unlike the side lasers, which are at isocenter height, the sagittal laser is typically mounted at a height of 7'-6"(2285) above the floor.

61.441

The two side laser positioning lights are located on the side walls at isocenter height.

64 - Cable Access Runs**64.506**

Provide two 4"(100) conduits tight to the ceiling, adjacent to the mechanical duct opening, to facilitate cable access for future room renovations. Review all vault penetrations with the Physicist of Record.

70 - Radiation Shielding**70.007**

Extent of primary beam. The total beam angle is 28 degrees (14 degrees either side of isocenter). Primary barrier shielding should extend a minimum 1'-0"(300) beyond edge of the primary beam. Do not locate sensitive electronics equipment (I.e. In Room Monitor) in the primary beam path.

70.087

An optional beamstopper may be used in lieu of increased primary barrier shielding. Shield vault for secondary shielding alone if a beamstopper is ordered. When the Gantry is rotated in certain positions, the beamstopper may interfere with some movements of the Couch. The presence of the beamstopper may preclude the addition of some accessory options. Consult with the Varian District Sales Manager for more information.

70.106

The amount and type of shielding on treatment room entrance doors have varying requirements based on the presence and length of the maze, and the energy of the Clinac. Generally, low energy Clinacs will require wood doors with a lead core and manual operation. Dual Energy Clinacs usually require steel doors with a lead and borated polyethylene core and motorized operation. Exact Clinac door shielding requirements are dependent on maze and shielding configuration. See typical minimum suggested door shielding. Clinac neutron leakage calculations down the maze follow the general guidelines of NCRP Report 79. A Varian monograph titled: "Neutron Doors for High Energy Accelerators", is available on request. As these doors do not have latching mechanisms, room air pressure must be positive relative to the department. Typically, shielded doors must be "exempted" where fire code labeling is required.

70.121

To reduce radiation exposure outside room, air handling ducts should enter/exit the room through penetration(s) above the maze door. The ducts should be placed as high as possible in order to minimize radiation exposure to occupied space. The ducts should be designed to minimize the area of penetration through the wall. In most cases, duct shielding will not be required, provided the duct design conforms to this criteria. Clear space should be left around the duct (outside the treatment room) for shielding retrofit, in case the post installation radiation survey indicates a requirement. Penetration, including ducts, directly into the treatment room should be avoided. For no-maze treatment rooms, duct design and shielding must be addressed by the Physicist of Record.

70.226

This is the secondary shielding.

70.437

This is the primary beam shielding.

VARIAN medical systems	[000] Refer to the Varian Components Chart at the end of this section.	Typical Room Configuration Clinac Linear Accelerators			
	Not For Construction				
1.23.2 :page	© Varian Medical Systems 2008 All rights reserved.	23Jan09	revision: 7	doc. #: 861626	page: 1.23.2
planning dept.					

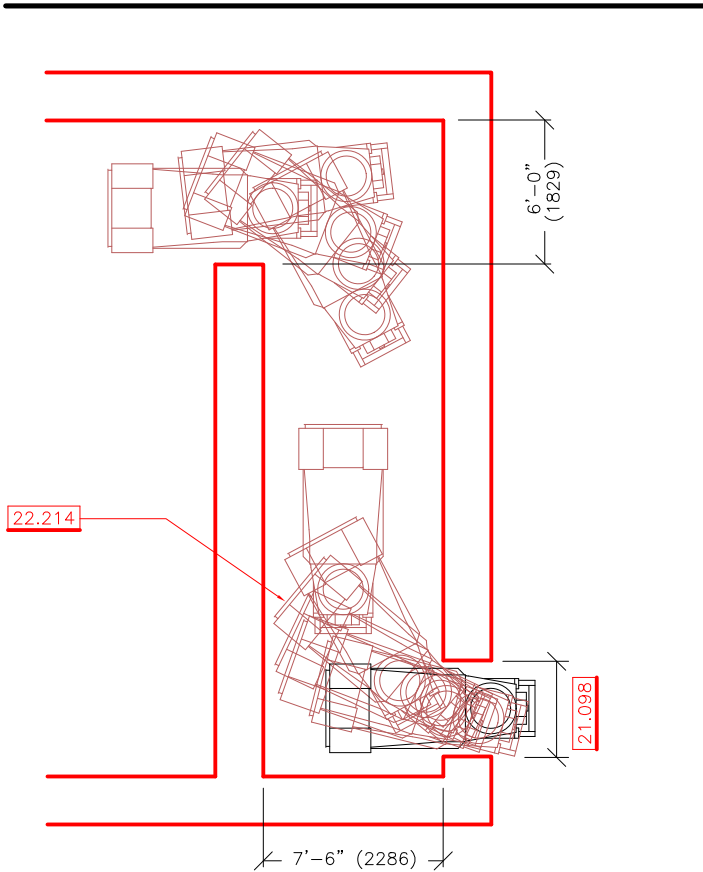

D Min. Rigging Clearances 10.089 22.213
Four-Piece Breakdown 22.225 22.514 IDP1041

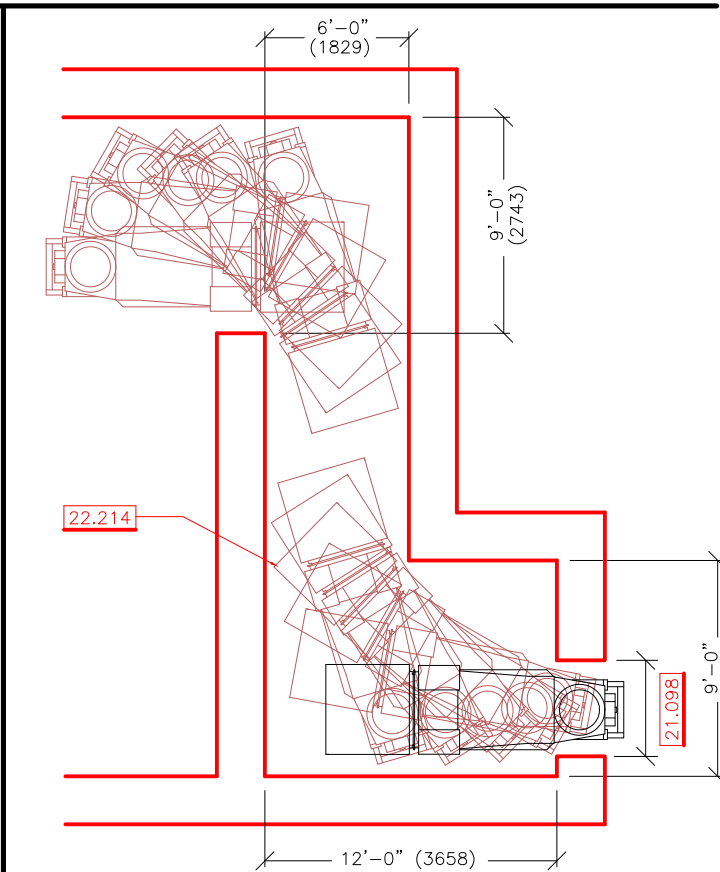

C Min. Rigging Clearances 10.089 22.213
Three-Piece Breakdown 22.225 22.514 IDP1040

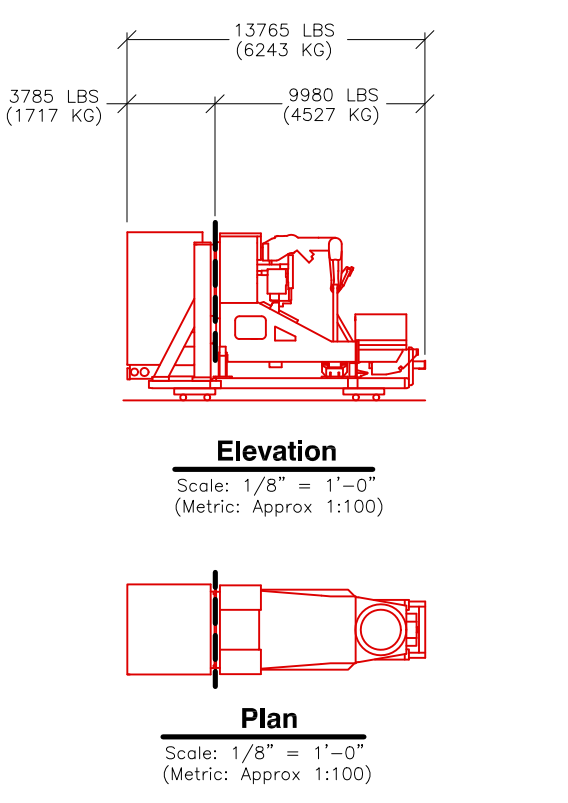

B Shipping Configuration 24.116 IDP1006

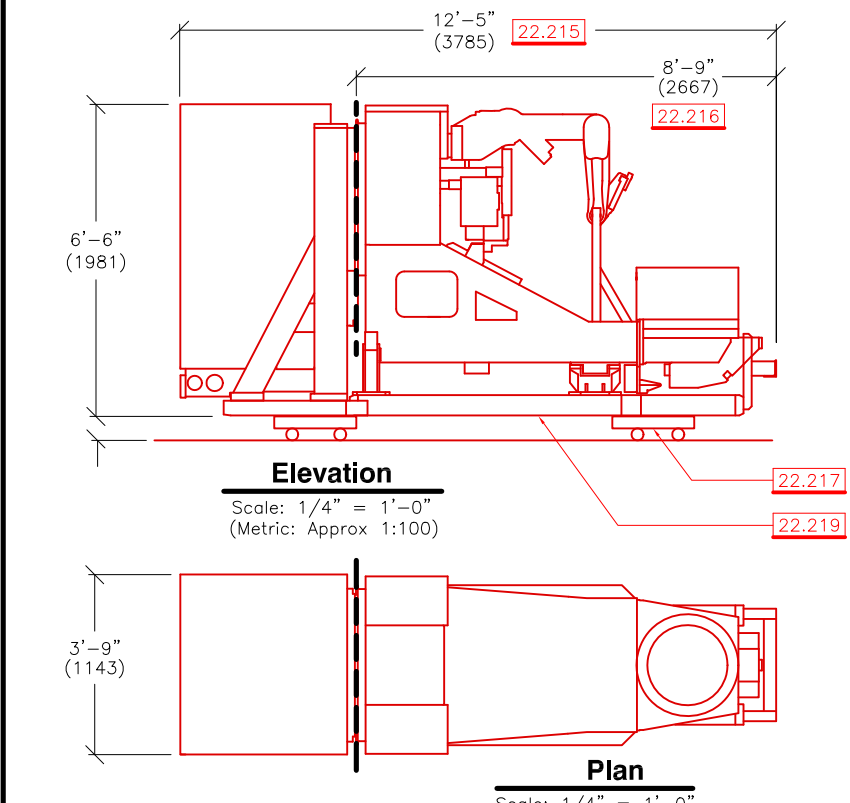

A Shipping Configuration 24.116 IDP1005

	Refer to the Varian Components chart at the end of this section.	Overlay - Shipping/Rigging Configuration			
	Not For Construction	Clinac Linear Accelerators			
1.24.0 :page	planning dept.	© Varian Medical Systems 2008 All rights reserved.	31Mar08	revision: 8	doc. #: 861652
					page: 1.24.0

10 - General Notes

10.089

The overlay sheets are designed to be copied onto clear acetate for use during project planning. Verify dimensional accuracy after duplication.

10.180

The information shown is for ALL Clinac linear accelerator models 2100C(D), 2300C/D, 21EX, 23EX, iX, Trilogy and Novalis Tx.

21 - Equipment Layout / Clearances

21.098

Provide a minimum 4'-0"(1220) clear by 7'-0"(2135) opening for equipment clearance at radiation shielded entrance doors to treatment rooms. This clearance allows proper access for rigging Varian equipment.

22 - Rigging

22.213

The dimensions shown on the rig route details are to face of finish and represent minimum configurations only. Verify adequate rigging clearances for specific site using the Shipping Configuration overlay. If the templates cannot be easily rotated through the maze without wall obstruction, review by a qualified Rigger will be required. Varian will review the installation route upon request. Coordinate all rigging with the Installation Project Manager. Final confirmation of rig route clearances and review of adequate structural support along the route is the responsibility of the Customer and the Structural Engineer of Record.

22.214

This is a sample 90 degree rigging turn.

22.215

This is the maximum dimension of the Clinac in its standard, three-piece breakdown.

22.216

This is the maximum dimension of the Clinac in its optional, four-piece breakdown. In this configuration, the Clinac Stand and Gantry are separated, at additional cost to the Customer, to reduce the rigging clearances required.

22.217

Appropriate rolling equipment shall be provided by the rigger.

22.219

A steel shipping pallet is provided by Varian.

22.225

Verify adequate equipment access into room and around maze.

22.514

Rigging is defined as the positioning of the Base Frame and Clinac or Acuity components into the treatment room. The Base Frame is rigged prior to the rest of the equipment and delivery must be scheduled by the construction Contractor with the Installation Project Manager. As designated in the final Varian/Customer Terms and Conditions of Sale, a rigging company is hired by the Customer or Varian to off-load these items from the truck and to move them through the facility and into the treatment room. The Customer's architect and structural engineers shall review the entire rig route for adequate clearance and structural support. The work can include temporary demolition and shoring. Final equipment positioning is part of the rigging contract.

24 - Installation Notes

24.116

During installation, several crates must be stored in a secure area of about 150 square feet (14 square meters). The number and size of the crates is shown on the Shipping List in the appropriate Equipment Information Section.

	[000] Refer to the Varian Components Chart at the end of this section.	Overlay - Shipping/Rigging Configuration Clinac Linear Accelerators				
	Not For Construction					
1.24.1 :page	planning dept.	© Varian Medical Systems 2008 All rights reserved.	31Mar08	revision: 8	doc. #: 861652	page: 1.24.1

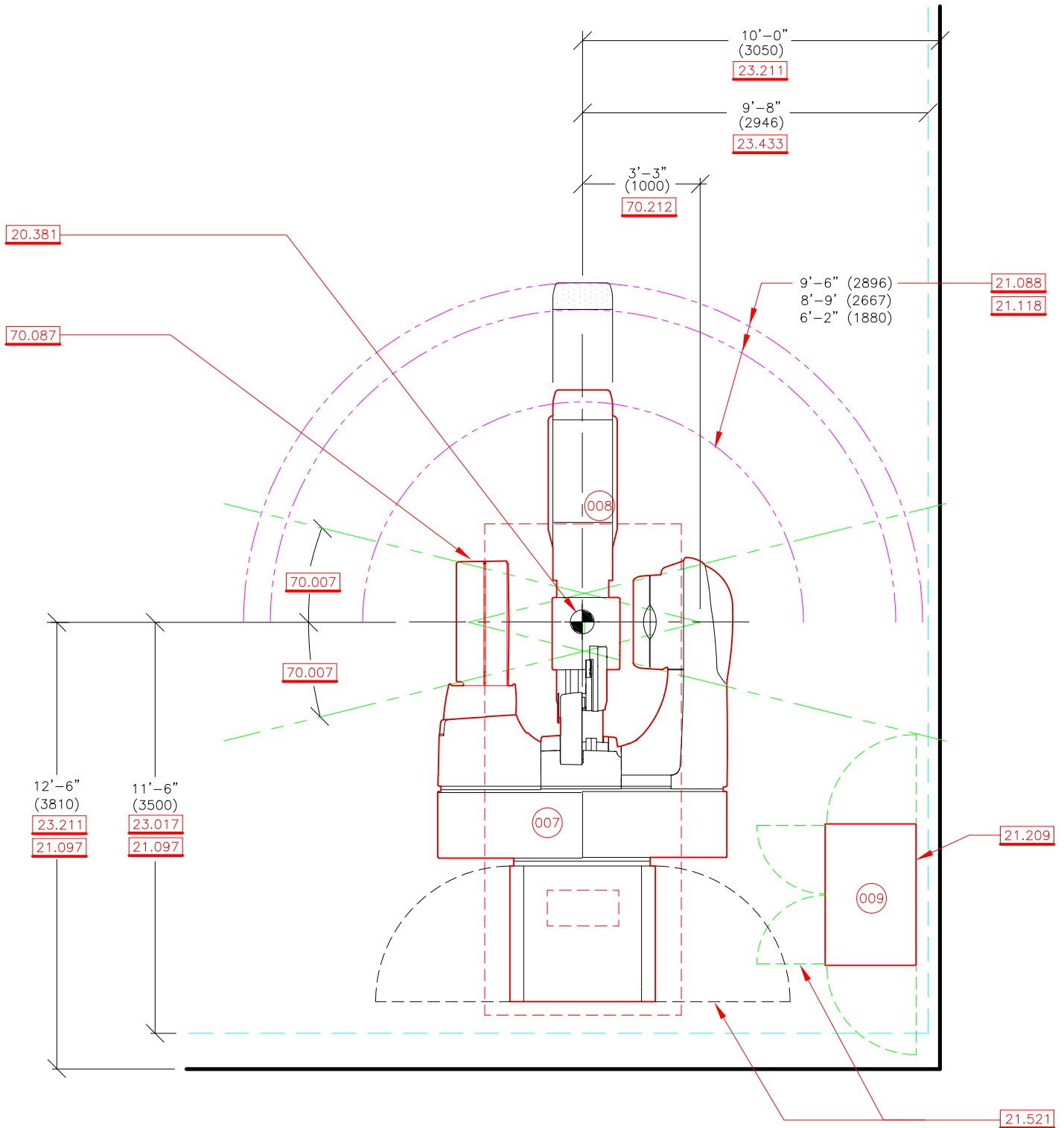

A Plan View Scale: 1/4" = 1'-0" Metric Approx: 1:50 [10.089] [21.088] IDP1008

scale at:	1 = 50	0	1	2	3	4	5	6
	1/4"=1'-0"	0	1	2	3	4	5	6

VARIAN medical systems	(000) Refer to the Varian Components chart at the end of this section.	Overlay - Plan View Clinac Linear Accelerators				
	Not For Construction					
1.25.0 :page	planning dept.	© Varian Medical Systems 2008 All rights reserved.	20Jul09	revision: 8	doc. #: 861651	page: 1.25.0

10 - General Notes

10.089

The overlay sheets are designed to be copied onto clear acetate for use during project planning. Verify dimensional accuracy after duplication.

10.180

The information shown is for ALL Clinac linear accelerator models 2100C(D), 2300C(D), 21EX, 23EX, iX, Trilogy and Novalis Tx.

20 - General Layout Notes

20.381

Isocenter - This is the primary reference point for Varian equipment. Show the isocenter location clearly on all relevant drawings. Maintain the isocenter location on site by extending perpendicular axis lines along slab and up walls in all four directions. The isocenter heights for Clinac Linear Accelerator and Silhouette are as follows:
 > Standard Isocenter Height - 4'-3" (1295)
 > Optional lowered Isocenter - 4'-1" (1245)

21 - Equipment Layout / Clearances

21.088

The recommended couch arc clearance allows complete rotation of the Couch at its maximum radius (retracted). Clearance that allows complete rotation of the Couch at its minimum radius, but with some obstruction of the maximum radius is acceptable, but must be reviewed by the Customer for specific clinical requirements. In specific situations, such as dynamic stereotactic treatment, a larger area may be required. Generally, the inability to rotate the Couch completely in its minimum position is unacceptable.

21.097

Isocenter-to-Back-Wall Clearance - Recommended clearance allows proper service, installation and air circulation clearances.

21.118

The Exact Treatment Couch 008 is standard with the Clinacs. The maximum Couch arc clearance is 9'-6"(2896). The maximum Couch arc clearance with Extension Panel removed is 8'-9"(2667). The minimum Couch arc clearance is 6'-2"(1880).

21.209

The Modulator Cabinet 009 may be located either in the Clinac room or remotely. Ventilation, acoustics, service provisions and cable length must be considered. The Modulator Cabinet has service panels at both sides and front. Provide 9'-0"(2750) clear space, side to side. If the Modulator Cabinet is located in a closet, verify local electronics cabinet clearance requirements with regional regulatory agencies. Do not locate this cabinet in the primary beam path.

21.521

The areas within the service clearance arcs must be free of obstructions. Adequate clearance must be provided beyond these arcs for service access.

23 - Dimension Descriptions

23.017

This is a minimum clear dimension.

23.211

This is the recommended dimension to concrete. Recommended face of concrete dimensions assume up to 6"(150) of wall furring.

23.433

This is the recommended minimum clear distance to the side wall for full couch rotation. Provide adequate additional clearance for side lasers.

70 - Radiation Shielding

70.007

Extent of primary beam. The total beam angle is 28 degrees (14 degrees either side of isocenter). Primary barrier shielding should extend a minimum 1'-0"(300) beyond edge of the primary beam. Do not locate sensitive electronics equipment (I.e. In Room Monitor) in the primary beam path.

70.087

An optional beamstopper may be used in lieu of increased primary barrier shielding. Shield vault for secondary shielding alone if a beamstopper is ordered. When the Gantry is rotated in certain positions, the beamstopper may interfere with some movements of the Couch. The presence of the beamstopper may preclude the addition of some accessory options. Consult with the Varian District Sales Manager for more information.

70.212

This is the dimension from the isocenter to the target, which is the source of x-ray production and is used to locate the primary beam spread.

	[000] Refer to the Varian Components Chart at the end of this section.	Overlay - Plan View Clinac Linear Accelerators			
	Not For Construction				
1.25.1 :page	planning dept.	© Varian Medical Systems 2008 All rights reserved.	20Jul09	revision: 8	doc. #: 861651 page: 1.25.1

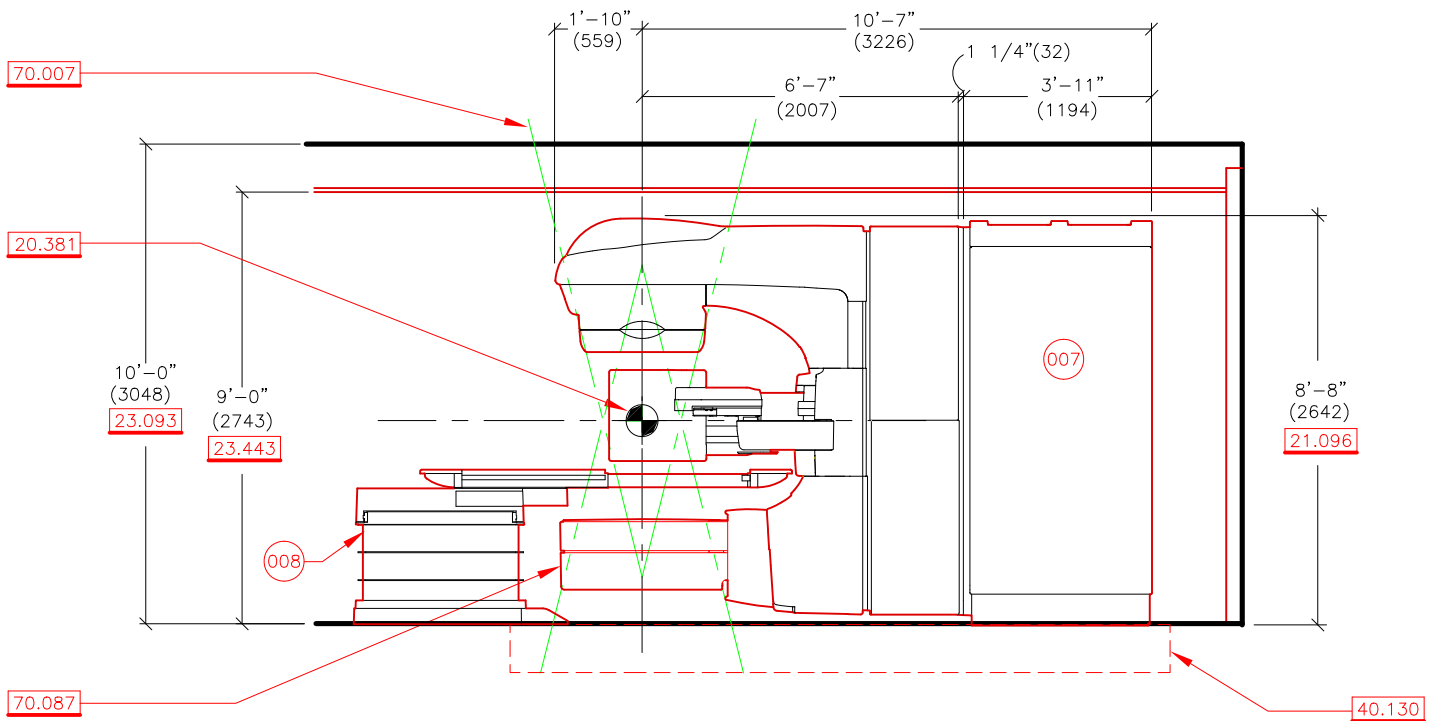

C Side Elevation

Scale: 1/4" = 1'-0"
Metric Approx: 1:50

10.089

IDP1012

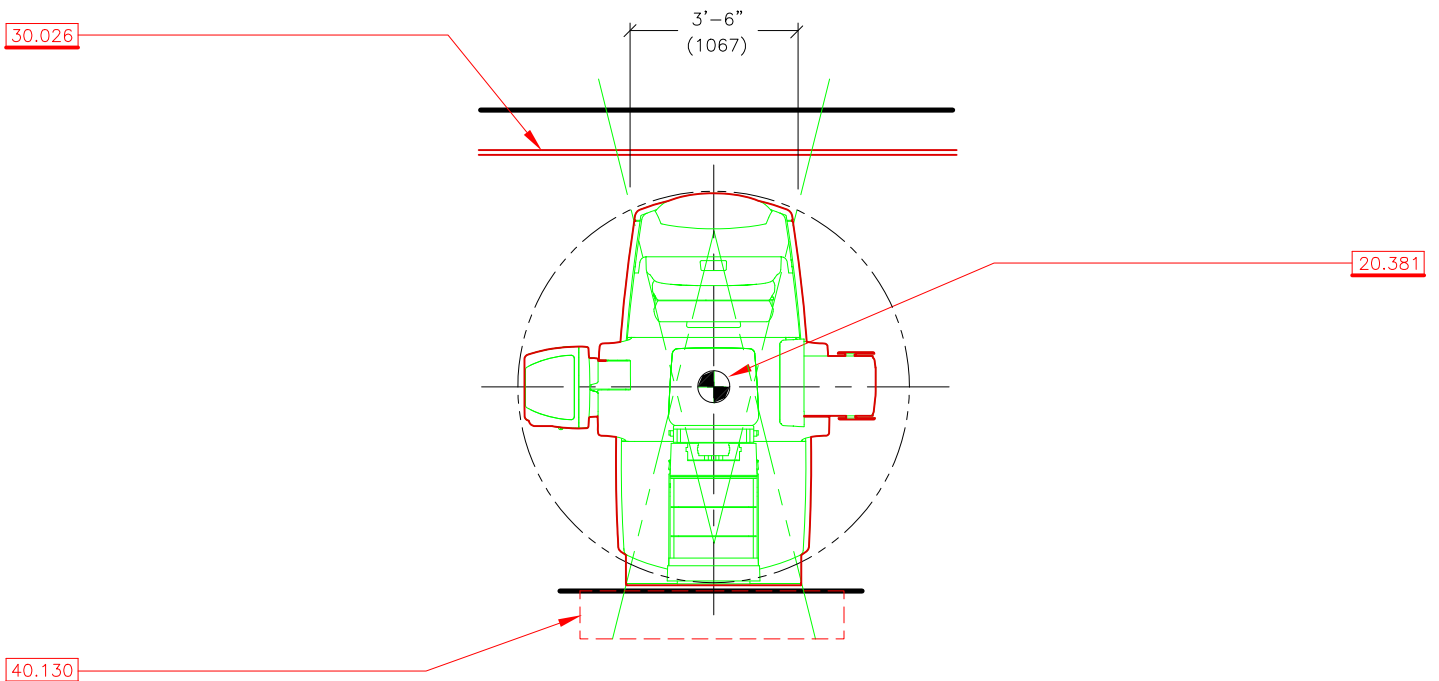

B Front Elevation

Scale: 1/4" = 1'-0"
Metric Approx: 1:50

10.089

IDP1011

scale at:	1 = 50	0	1	2	3	4	5	6
	1/4"=1'-0"	0	1	2	3	4	5	6
VARIAN medical systems	Refer to the Varian Components chart at the end of this section.		Overlay - Elevations Clinac Linear Accelerators					
1.26.0 :page	planning dept.	© Varian Medical Systems 2008 All rights reserved.		20Jul09	revision: 8	doc. #: 861654	page: 1.26.0	

10 - General Notes

10.089

The overlay sheets are designed to be copied onto clear acetate for use during project planning. Verify dimensional accuracy after duplication.

10.180

The information shown is for ALL Clinac linear accelerator models 2100C(D), 2300C/D, 21EX, 23EX, iX, Trilogy and Novalis Tx.

20 - General Layout Notes

20.381

Isocenter - This is the primary reference point for Varian equipment. Show the isocenter location clearly on all relevant drawings. Maintain the isocenter location on site by extending perpendicular axis lines along slab and up walls in all four directions. The isocenter heights for Clinac Linear Accelerator and Silhouette are as follows:
> Standard Isocenter Height - 4'-3" (1295)
> Optional lowered Isocenter - 4'-1" (1245)

21 - Equipment Layout / Clearances

21.096

Gantry-Ceiling Clearance - Minimum clearance allows Gantry rotation with 2"(50) of clearance for obstructions, air circulation and service clearance above the Stand. Final height is determined by Isocenter height.

23 - Dimension Descriptions

23.093

This is the recommended minimum dimension to concrete above. This dimension allows minimum clearance for laser and utilities above ceiling.

23.443

This is the recommended minimum clear dimension to the ceiling over the equipment Stand and Gantry.

30 - Finishes

30.026

Exposed grid ceilings allow for access to the overhead laser and Relay Junction Box without the use of access doors. Major service at the equipment Stand is simplified where there are removable ceiling tiles. Coordinate the layout of ceiling tile to insure that ceiling support system shall not interfere with overhead laser positioning light beam port.

40 - Base Frame Installation / Anchorage

40.130

This is the out line of Base Frame pit recess.

70 - Radiation Shielding

70.007

Extent of primary beam. The total beam angle is 28 degrees (14 degrees either side of isocenter). Primary barrier shielding should extend a minimum 1'-0"(300) beyond edge of the primary beam. Do not locate sensitive electronics equipment (I.e. In Room Monitor) in the primary beam path.

70.087

An optional beamstopper may be used in lieu of increased primary barrier shielding. Shield vault for secondary shielding alone if a beamstopper is ordered. When the Gantry is rotated in certain positions, the beamstopper may interfere with some movements of the Couch. The presence of the beamstopper may preclude the addition of some accessory options. Consult with the Varian District Sales Manager for more information.

	[000] Refer to the Varian Components Chart at the end of this section.	Overlay - Elevations Clinac Linear Accelerators				
	Not For Construction					
1.26.1 :page	planning dept.	© Varian Medical Systems 2008 All rights reserved.	20Jul09	revision: 8	doc. #: 861654	page: 1.26.1

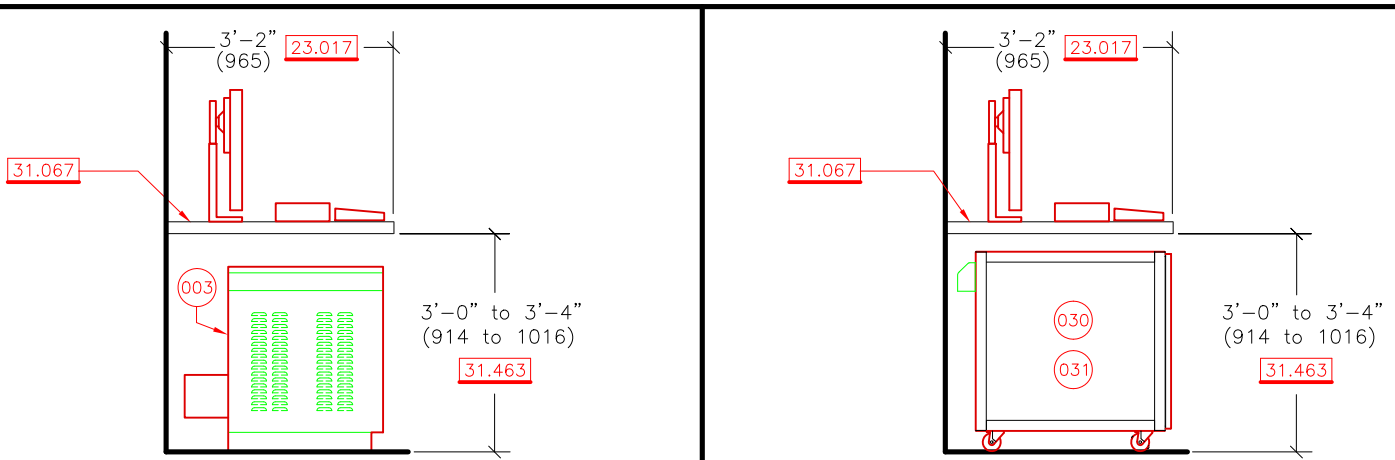

E Typical Section at Clinac Control

IDP1074

D Typical Section at Control Cabinet

IDP1073

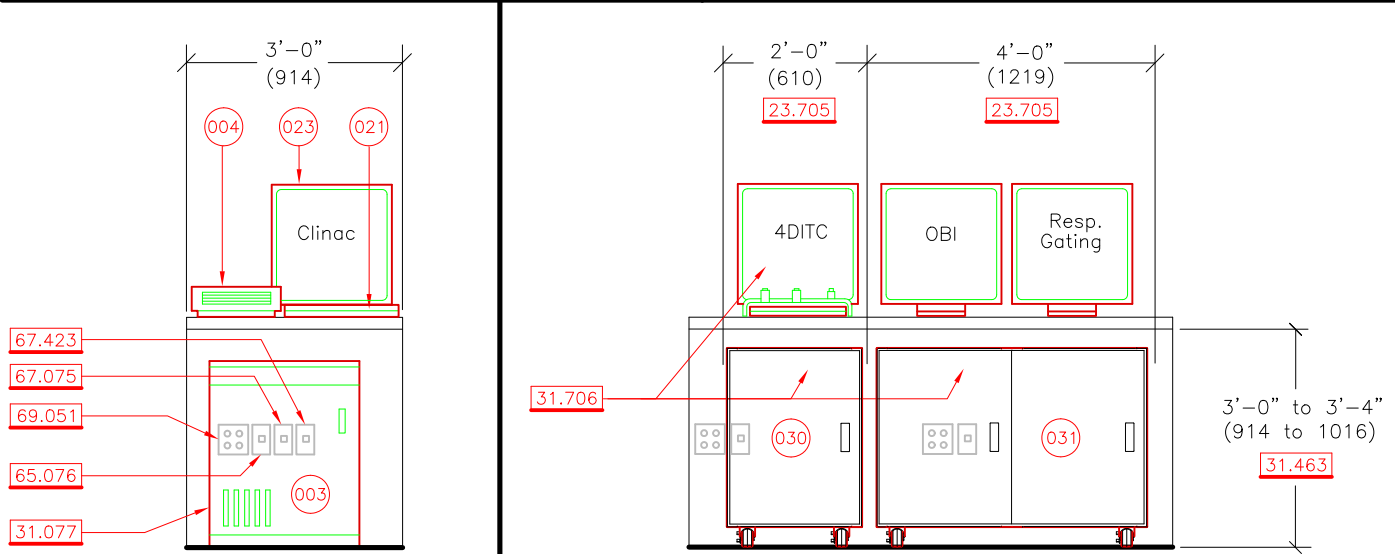

C Clinac Control Equipment

IDP1072

B Front Elevation - Control Cabinet

IDP1071

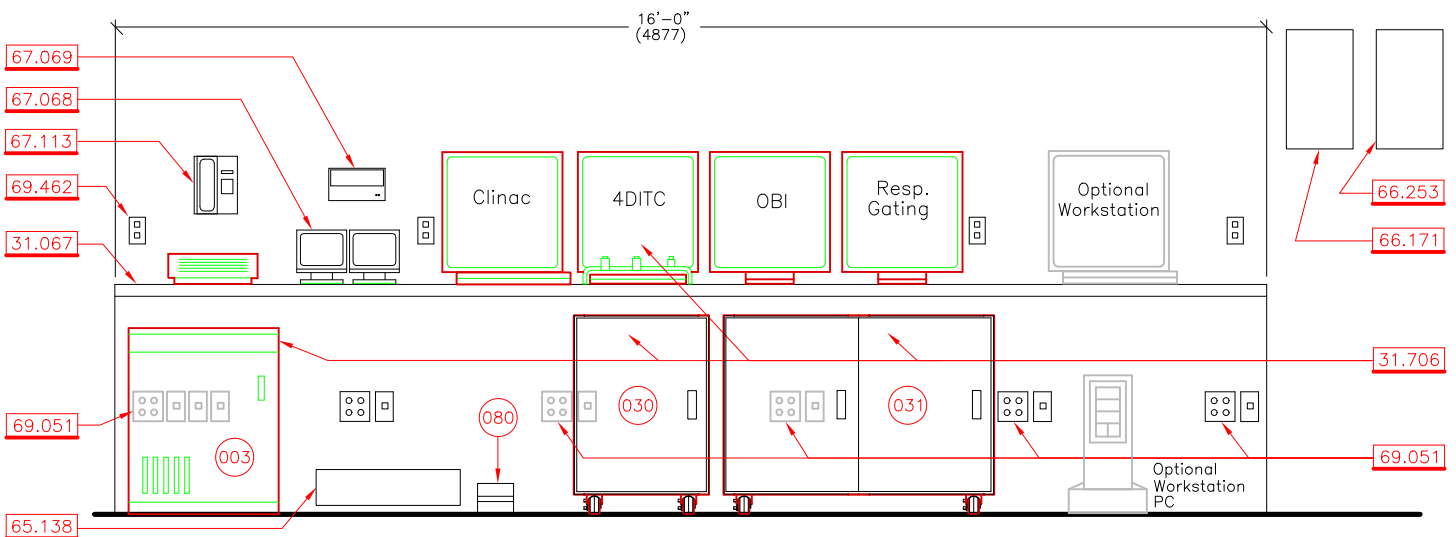

A Layout Elevation

10.180 30.024 31.071 31.084 31.086 53.707

IDP1070

scale at: 3/8" = 1'-0"

	(000) Refer to the Varian Components chart at the end of this section.	Typical Control Equipment Casework Clinac Linear Accelerators				
		Not For Construction				
1.27.0 :page	planning dept.	© Varian Medical Systems 2008 All rights reserved.	12Feb09	revision: 0	doc. #: 200072	page: 1.27.0

10 - General Notes

10.180

The information shown is for ALL Clinac linear accelerator models 2100C(D), 2300C(D), 21EX, 23EX, iX, Trilogly and Novalis Tx.

23 - Dimension Descriptions

23.017

This is a minimum clear dimension.

23.705

This is the minimum dimension for control console cabinet clearance. Do not install wall or counter support brackets in these areas.

- > Clinac Electronics Cabinet 003 - 24"W X 34" H X 38"D (610 X 864 X 965)
- > Control Console Cabinet 030 - 24"W X 34" H X 38"D (610 X 864 X 965)
- > Control Console Cabinet 031- 48"W X 34" H X 38"D (1219 X 864 X 965)

30 - Finishes

30.024

As with most computer components, the electronic components for this equipment are sensitive to localized static electricity. Carpeting or other flooring adjacent to the equipment in the room or at the control equipment area should not exceed a 2.0 kV rating at 20% relative humidity when measured as outlined by the methods in AATCC-134. Retrofit static dissipative coatings are also available from various manufacturers. Carpet, while otherwise advantageous, can make gurney movement difficult. Floor stains are common due to the use of dyes to mark reference points on patients. Many facilities use carpet squares that can be replaced or cleaned and allow access to floor duct if used.

31 - Control Equipment Casework

31.067

Provide 3"(75) diameter grommeted holes as required at counter and shelf for cables (typical). If possible, in order to accommodate on-site Customer preferences and possible changes in equipment configuration, locate and drill holes after the control equipment has been arranged on location. A gap or slots at the back of the counter and shelf for cable access is also acceptable.

31.071

Provide a minimum 3"(75) air and cable space at sides, top and rear of all computers and monitors.

31.077

Locate the Clinac Electronics Cabinet 003 to the left of and within sight of Clinac Console if possible. This location simplifies equipment service, but placement at other locations does not affect the operability of the system. The Clinac Electronics Cabinet 003 as shipped rests on castors. Where positive seismic anchoring of Clinac Electronics Cabinet 003 is required, provide removable counter over cabinet for service access.

31.084

This control equipment casework design is provided as a suggestion for possible component arrangement only. The counter design shown is recommended because it allows for final component placement adjustments on site to suit personal preference and can accommodate future equipment upgrades and additional options. Optional equipment is often added after the Clinac has been installed and should be planned for even if they are not part of the initial order. The control equipment location should be as close to the treatment room door as possible to provide control over the entrance and reduce the travel distance. CCTV, cabinetry, intercom and phones are Customer-supplied items, shown on Varian drawings for illustrative purposes only. It is often desirable to locate the control equipment facing in a direction that allows the therapists to visually control the adjacent area. This layout can also reduce the visibility of CCTV monitors for patient privacy.

31.086

Provide additional control area storage and workspace as needed. Typical storage requirements include space for films, charts and personal belongings.

31.463

The recommended counter height range shown assumes that the therapists are standing or using stools during typical treatment cycles. Some facilities provide areas at the control area designed for chair height. Adjust dimensions at these areas as required.

31.706

- > Locate Control Console Cabinet 030 and 031 within 15'-0" (4572) of Clinac Electronics Cabinet 003.
- > Locate Control Console Cabinet 030 and 031 within 15'-0" (4572) of each other.
- > Locate Control Console Cabinet 030 and 031 within 8'-0" (2438) of the control console OBI/4DITC/Gating monitors.

53 - Ventilation

53.707

Provide ventilation sufficient for removal of control console air heat load as follows:

- > Clinac Electronics Cabinet 003 > 1.0 kW (3,415 Btu/hr)
- > Control Console Cabinet 030 > 1.5 kW (5,123 Btu/hr)
- > Control Console Cabinet 031 > 2.3 kW (7,855Btu/hr)
- > ARIA Option Workstation > 0.5 kW (1,707 Btu/hr)

65 - Pull / Junction Boxes

65.076

Provide a signal pull box for the In-Room Monitor. This is a standard computer signal cable outlet. If the signal cables are to be recessed, provide a signal outlet and conduits from the in-room monitor to the Control Equipment console.

65.138

The Control Equipment pull box shall have a minimum size of 24" X 12" X 6" deep (610 X 300 X 150). This pull box may be wall mounted or accessed similar to details in Base Frame Cable Access Details. Locate this pull box so that the free ends of cables are protected from physical damage and located within 5'-0"(1525) of the Clinac Electronics Cabinet 003. As no connections are made at this location, many regulatory agencies do not require a pull box.

66 - Circuit Breakers / UVRs

66.171

The On-Board Imager Main Circuit Breaker Panel may be flush mounted on, or recessed in the wall. If recessed, provide a minimum 6"(150) thick wall. Locate within sight of and within 10'-0"(3050) of Clinac control equipment casework. Conspicuously identify as "Disconnect for OBI".

> Main Circuit Breaker Panel, recommended G.E. Catalog # OBI60A480V (includes 60A, 3-phase 400 - 480V circuit breaker, 60A, 480V contactor/120V coil installed in a Lockout/Tagout subpanel) or equivalent. The On-Board Imager Main Circuit Breaker Panel is available from GEXPRO (800-200-9760 X3876 or 317-554-3876) Catalog #OBI60A480V and ordering information is available from the Planning department web page: varian.com/architectural support or contact your regional Planning Manager.

66.253

The Main Circuit Breaker Panel may be flush mounted on, or recessed in, wall. If recessed, provide a minimum 6"(150) thick wall. Locate within sight of and within 10'-0"(3050) of Clinac control equipment casework.

67 - Communications

VARIAN medical systems	[000] Refer to the Varian Components Chart at the end of this section.	Typical Control Equipment Casework Clinac Linear Accelerators				
	Not For Construction					
1.27.1 :page	planning dept.	© Varian Medical Systems 2008 All rights reserved.	12Feb09	revision: 0	doc. #: 200072	page: 1.27.1

67.068

CCTV monitors may be mounted on or under shelf and must be visible during treatment. The CCTV monitors must be located with patient privacy in mind. Monitors are often recessed in the control console casework and viewed through cut-outs covered with glass. Small, high-resolution monitors may be more exposed as the image is not clear from a distance. Provide a power receptacle for the monitors. Refer to the CCTV System manufacturer's literature for conduit, mounting and installation requirements. A non-interruptible power source may be required by regulatory code.

67.069

Provide a two-way patient monitoring intercom system. The in-room intercom may be wall and/or ceiling mounted and should be voice-activated or continuous-on. The intercom at the control equipment area should be push-to-talk. Provide a signal conduit from the control equipment area and power to the intercom. Refer to the intercom manufacturer's literature for conduit, mounting and installation requirements. A non-interruptible power source may be required by regulatory code.

67.075

Provide an outside phone line for remote diagnostics modem. This line must be dedicated to data transmission and shall not go through a PBX or similar phone system.

67.113

Provide convenience phone jacks as required. A phone jack should be provided at any Varian equipment cabinet not located in the equipment room, near the equipment and within the control equipment casework. The phone system shall be operational prior to the equipment installation.

67.423

Provide network cabling outlets at all server or workstations equipment locations. All network cabling and jacks must be minimum CAT5e. All network connections must operate at a minimum of 100 Mbit full duplex. TCP/IP data drops must be active at the time of installation. Network patch panels, hubs and routers are typically located in a server room or closet.

69 - Power Receptacles / Switches

69.051

Provide grounded 4 plex electrical power receptacles for Varian control console equipment. Locate adjacent to the underside of the counter to provide maximum power cable extension.

69.462

Provide convenience electrical power receptacles as required.

	[000] Refer to the Varian Components Chart at the end of this section.	Typical Control Equipment Casework Clinac Linear Accelerators			
	Not For Construction				
1.27.2 :page	planning dept.	© Varian Medical Systems 2008 All rights reserved.	12Feb09	revision: 0	doc. #: 200072 page: 1.27.2

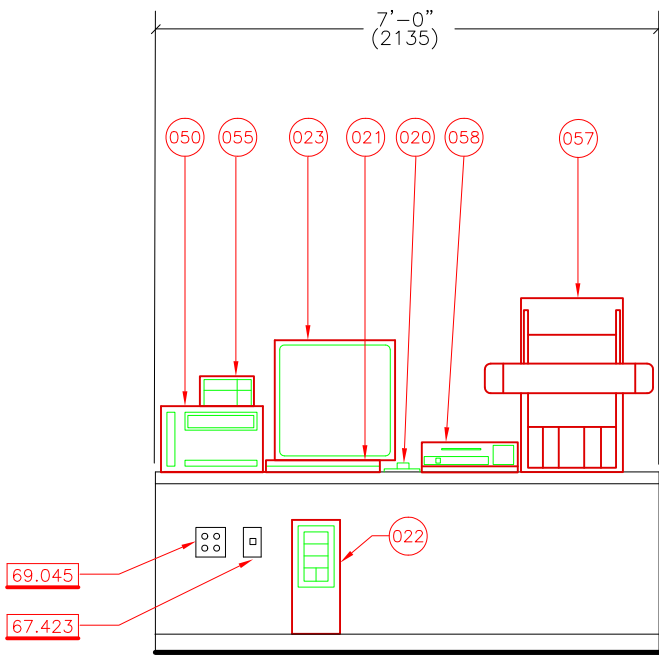

E PV Option Remote Viewing Station 21.510

IDP1028

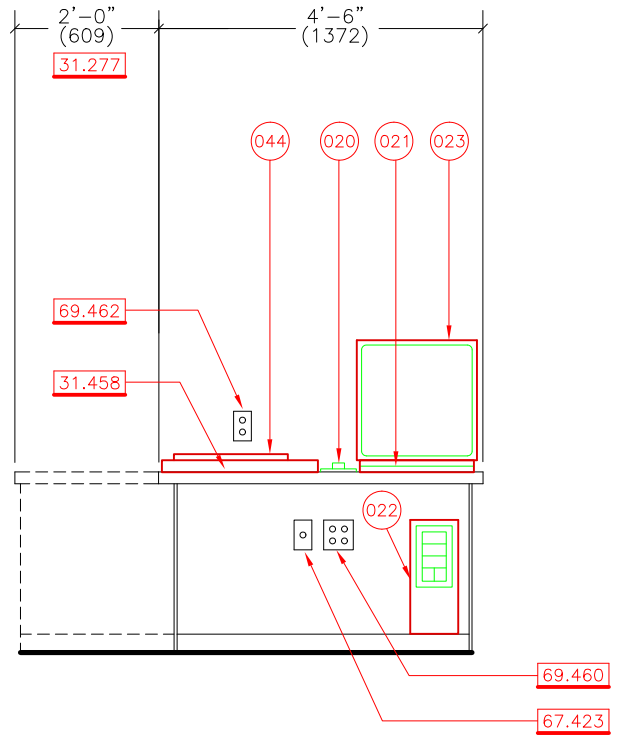

D MLC Option Editing Station 21.511

IDP1027

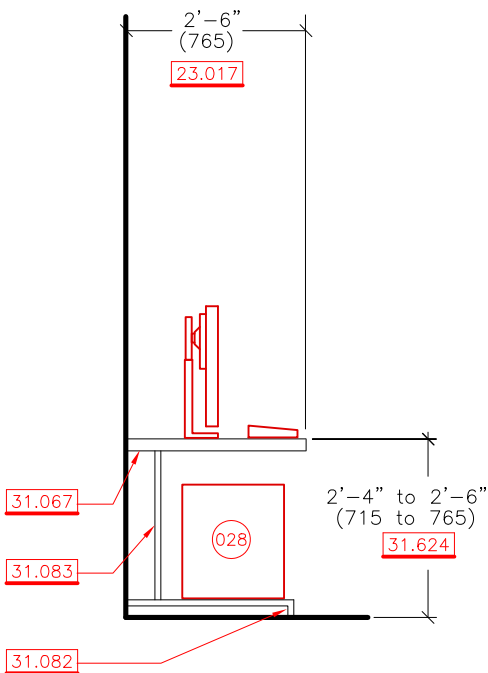

C Typical Counter Section 31.071

IDP1026

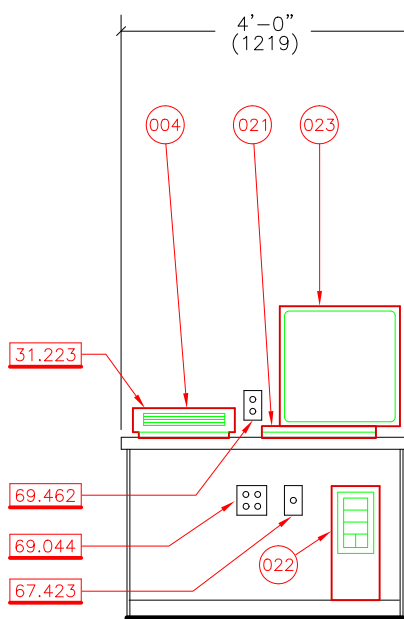

B ARIA Option Editing Station 21.509 21.524

IDP1025

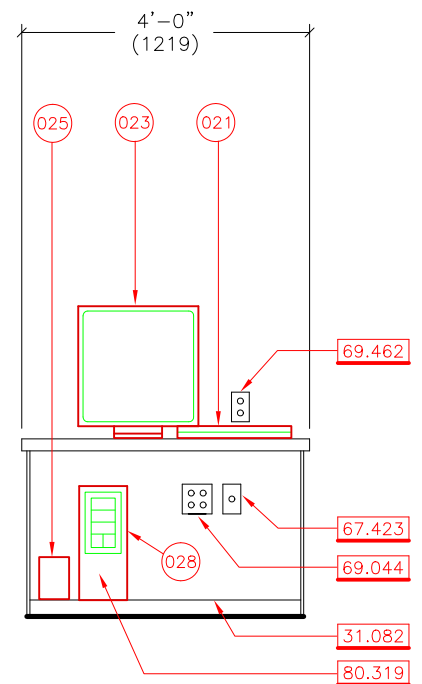

A ARIA Option File Server 21.524

IDP1024

scale at: 3/8" = 1'-0"

		Typical Remote Workstations Clinac Linear Accelerators				
	Not For Construction					
1.28.0 :page	planning dept.	© Varian Medical Systems 2008 All rights reserved.	31Mar08	revision: 4	doc. #: 1100775	page: 1.28.0

10 - General Notes

10.180

The information shown is for ALL Clinac linear accelerator models 2100C(D), 2300C(D), 21EX, 23EX, iX, Trilogy and Novalis Tx.

21 - Equipment Layout / Clearances

21.509

ARIA is an optional computer system designed for use with Clinacs and Acuity to display, verify and store patient records. The control area Editing Workstation can be linked by the File Server to form a local area network. Additional Editing Workstations may be located throughout the radiotherapy department.

21.510

PortalVision (PV) is an optional real-time imaging system for monitoring and verification of the Clinac treatment field and shielding blocks in relation to anatomical landmarks. The Acquisition Station is located at the Clinac control equipment area. A Remote Viewing Station is usually located in the treatment planning area, but may be located at the control equipment area. If multiple Viewing Stations are provided, the additional stations do not require digitizers or printers.

21.511

The Multileaf Collimator (MLC) is an optional collimator system for the Clinacs that defines the silhouette of the radiation beam. This system reduces the need for blocks and block trays. An Editing Station is located at the control equipment area. A remote Editing Station with a digitizer is usually located in the treatment planning area.

21.524

The ARIA product is a complete oncology department information management system that can range from 4 workstations and 1 server to 100 workstations and 3-4 servers. It's made up of a suite of software application modules that reside on PC workstations throughout the department and possibly at other remote facilities via wide area networks. Workstations are connected over a network to centrally located computer servers. Customers have the option to provide the PC computers providing they meet Varian's recommendations. Network infrastructure is generally provided and setup for ARIA either by the hospital IS department or through hospital networking contractors. A typical department will have 8-16 PC workstations around the department for staff to use. The servers should be located in an out of the way area, preferably in air conditioned and locked closets with the other network components (hubs, switches, patch panels).

For each Clinac there will be a companion ARIA Treatment workstation that sits next to the Clinac console on the counter top. If the Clinac also has the MLC and/or PV option the workstation will be shared between ARIA and MLC and PV. ARIA, MLC and PV all require additional control computers at the console area. The ARIA VM/IRM control computer uses the large In-Room monitor for its display. The MLC and PV control computers each have their own monitors however these are used only during setup/service. The control computer keyboards/mouse's can be located in service drawers.

23 - Dimension Descriptions

23.017

This is a minimum clear dimension.

31 - Control Equipment Casework

31.067

Provide 3"(75) diameter grommeted holes as required at counter and shelf for cables (typical). If possible, in order to accommodate on-site Customer preferences and possible changes in equipment configuration, locate and drill holes after the control equipment has been arranged on location. A gap or slots at the back of the counter and shelf for cable access is also acceptable.

31.071

Provide a minimum 3"(75) air and cable space at sides, top and rear of all computers and monitors.

31.082

Provide minimum 4"(100) high platform at computers under the counter to prevent damage. The flooring may be covered up the platform edge for ease of cleaning. Verify under counter clearance height. Where space permits, these components may be located on the counter.

31.083

A removable panel may be used below control equipment casework to hide cables and receptacles.

31.223

A paper supply stand is provided with the Log Printer.

31.277

Recommend 2'-0"(610) additional clearance for a Customer-supplied MLC plotter.

31.458

Provide a light box or recessed light table with a surface area of 20"(510) wide by 25"(635) deep. The MLC Digitizer [044] rests on top of this light box.

31.624

The recommended counter height range shown assumes that the therapists are seated during typical treatment cycles. Some facilities provide areas at the control area designed for stool height. Adjust dimensions at these areas as required.

67 - Communications

67.423

Provide network cabling outlets at all server or workstations equipment locations. All network cabling and jacks must be minimum CAT5e. All network connections must operate at a minimum of 100 Mbit full duplex. TCP/IP data drops must be active at the time of installation. Network patch panels, hubs and routers are typically located in a server room or closet.

69 - Power Receptacles / Switches

69.044

Provide a grounded 4 plex electrical power receptacle for ARIA option components. Locate adjacent to the underside of the counter to provide maximum power cable extension room.

69.045

Provide a grounded 4 plex electrical power receptacle for Portal/Vision (PV) option components. Locate adjacent to the underside of the counter to provide maximum power cable extension room.

69.460

Provide a grounded 4 plex electrical power receptacle for Multileaf Collimator (MLC) option components. Locate adjacent to the underside of the counter to provide maximum power cable extension room.

69.462

Provide convenience electrical power receptacles as required.

80 - Room Labels / Descriptions

80.319

The ARIA/Eclipse Servers should be located in an air conditioned server room or well ventilated central location. Routine access to the Server is usually not required, except by authorized service personnel. Depending on purchased options there could be 1-4 servers.



[000] Refer to the Varian Components Chart at the end of this section.

Not For Construction

© Varian Medical Systems 2008
All rights reserved.

Typical Remote Workstations Clinac Linear Accelerators

1.28.1 :page

planning
dept.

31Mar08

revision: 4

doc. #: 1100775

page: 1.28.1

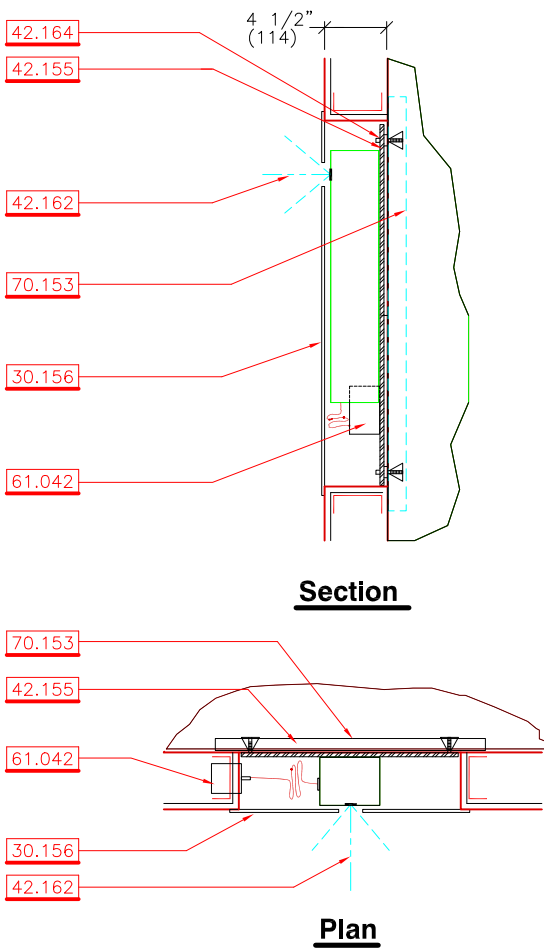
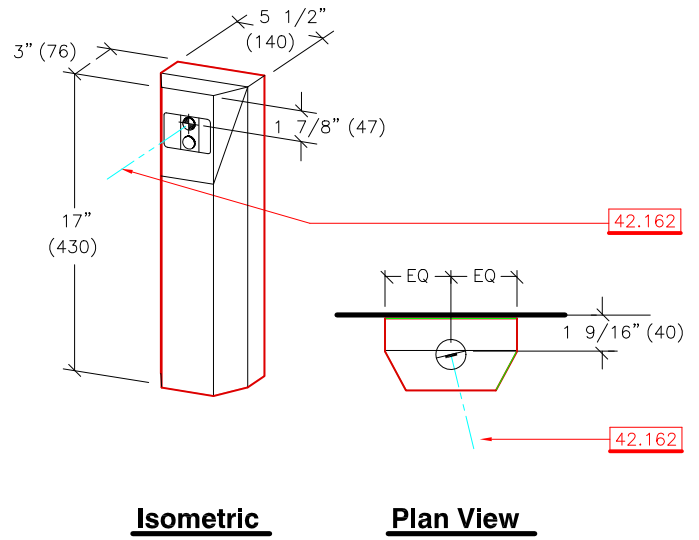
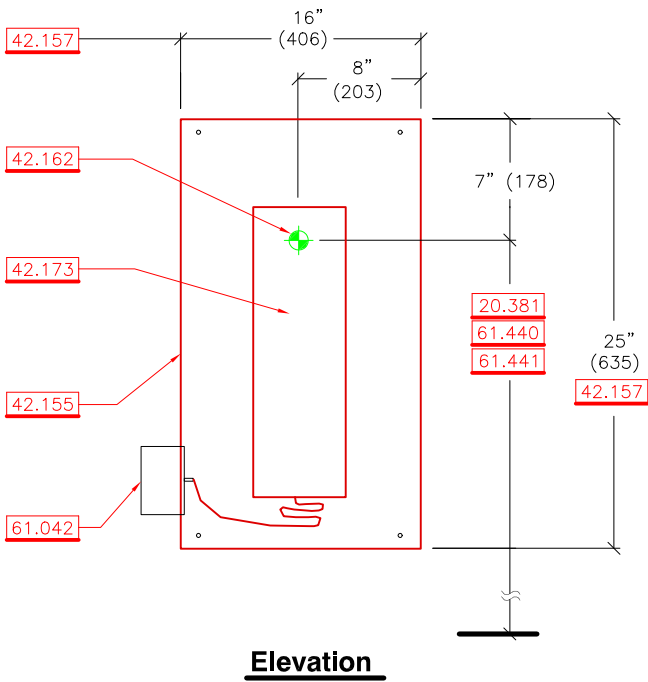

B Laser Positioning Light 61.111

IDP1031

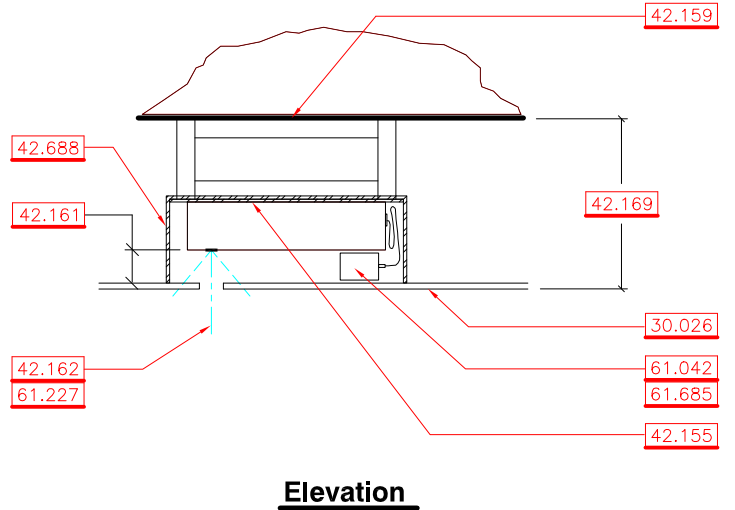

Turret Laser Mounting

C Details Recessed in Wall Furring

IDP1032

A Ceiling Mount Detail

IDP1029

	000 Refer to the Varian Components chart at the end of this section.	Laser Positioning Lights Clinac Linear Accelerators				
	Not For Construction					
1.29.0 :page	planning dept.	© Varian Medical Systems 2008 All rights reserved.	31Mar08	revision: 5	doc. #: 1100767	page: 1.29.0

10 - General Notes

10.180

The information shown is for ALL Clinac linear accelerator models 2100C(D), 2300C(D), 21EX, 23EX, iX, Trilogy and Novalis Tx.

20 - General Layout Notes

20.381

Isocenter - This is the primary reference point for Varian equipment. Show the isocenter location clearly on all relevant drawings. Maintain the isocenter location on site by extending perpendicular axis lines along slab and up walls in all four directions. The isocenter heights for Clinac Linear Accelerator and Silhouette are as follows:

- > Standard Isocenter Height - 4'-3" (1295)
- > Optional lowered Isocenter - 4'-1" (1245)

30 - Finishes

30.026

Exposed grid ceilings allow for access to the overhead laser and relay junction box without the use of access doors. Major service at the equipment Stand is simplified where there are removable ceiling tiles. Coordinate the layout of ceiling tile to insure that ceiling support system shall not interfere with overhead laser positioning light beam port.

30.156

Decorative laser recess covers (by Customer) must allow full access to recess. Do not apply drywall over decorative cover. Drill laser beam hole in cover after laser is installed.

42 - Laser Positioning Light Mounting

42.155

1/4"(6) thick x 16"(406) x 25"(635) mild steel plate required for mounting. Provide 1-1/2"(38) thick steel shielding with a 1"(25) margin behind laser if laser is recessed in concrete (thickness may vary depending on depth of recess).

42.157

Furring shall not overlap steel plate. Laser recess minimum dimensions exceed laser dimensions to allow for adjustment during installation.

42.159

Securely anchor the ceiling laser support structure to the rigid structure above.

42.161

Provide 3"(75) clearance from the bottom of the overhead laser to the ceiling to permit access.

42.162

The beam port center line is the primary reference point laser location.

42.164

Expansion shields are typically used to anchor the steel laser mounting plate to the concrete structure. Provide minimum 1/8"(4) thick washers between the mounting plate and the concrete. The steel laser mounting plate must be installed level and plumb in both planes.

42.169

Provide Unistrut or similar rigid box frame where dimensions exceed 2'-0"(600). Surface mount laser on steel plate where ceiling to concrete distance is less than 2'-0"(600).

42.173

Do not mount lasers on sheet rock, drywall or suspended ceilings. Secure directly to rigid structure. Varian strongly recommends that a steel plate be provided for installation onto concrete walls. Without rigidly mounted steel plate backing for lasers, stable isocenter positioning cannot be guaranteed. The differential movement between the laser location and the isocenter shall not exceed 1mm. Do not mount lasers until isocenter has been established. Lasers may be installed "upside down" (with the beam port nearest the bottom of laser) or "sideways" at locations with obstructions below laser. If the lasers are provided by Varian, the laser mounting will be done by Varian. Otherwise the laser mounting is to be done by the Customer.

42.688

Verify appropriate code for enclosure requirements.

61 - Laser Positioning Lights

61.042

The power to lasers is typically supplied by a grounded power receptacle at each laser location. A 3'-0"(900) power cord is provided with each laser. The receptacles are controlled through the Relay Junction Box as defined by the Interconnection Wiring Diagram. Each laser consumes 25W.

61.111

The patient's position on the Couch is fixed by body markings that are aligned with "cross hairs" cast by the laser lights. Two wall laser positioning lights at isocenter height, a ceiling laser and the sagittal laser are powered by a common circuit controlled via the user interface in the Control Room or Couch Pendant or Couch Side Panels, through a relay. Lasers are usually distributed and installed, at the Customer's option, by Varian. The Customer is responsible for verification of laser types and mounting configurations.

61.227

The overhead laser positioning light is located directly over the isocenter.

61.440

The sagittal laser positioning light is located on the wall at the end of the longitudinal couch axis. Unlike the side lasers, which are at isocenter height, the sagittal laser is typically mounted at a height of 7'-6"(2285) above the floor.

61.441

The two side laser positioning lights are located on the side walls at isocenter height.

61.685

Mount the 120v power receptacle on the vertical surface of the enclosure.

70 - Radiation Shielding

70.153

Provide adequate radiation shielding (usually lead or steel with a 1"(25) margin) behind all junction and pull boxes recessed in concrete walls. Verify thickness and location with the Physicist of Record.

	[000] Refer to the Varian Components Chart at the end of this section.	Laser Positioning Lights Clinac Linear Accelerators				
	Not For Construction					
1.29.1 :page	planning dept.	© Varian Medical Systems 2008 All rights reserved.	31Mar08	revision: 5	doc. #: 1100767	page: 1.29.1

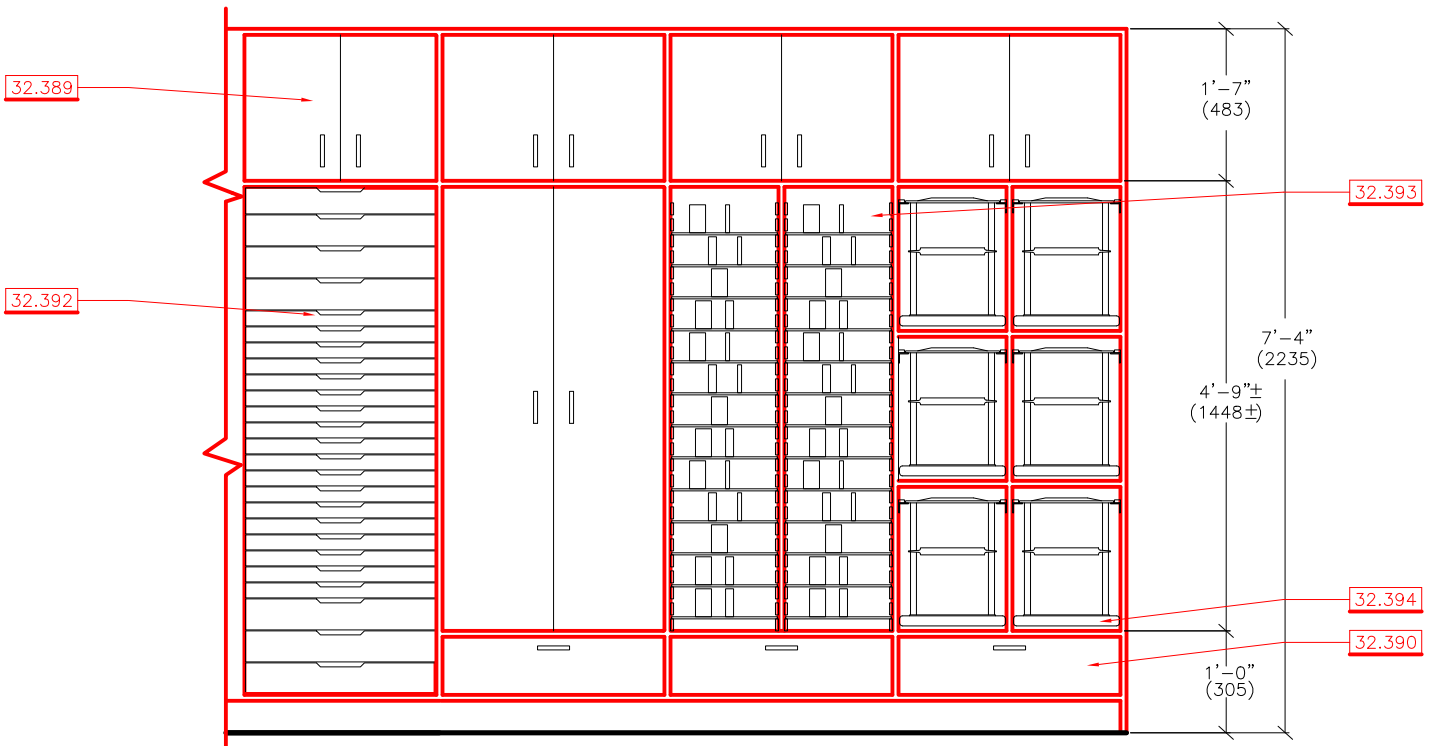
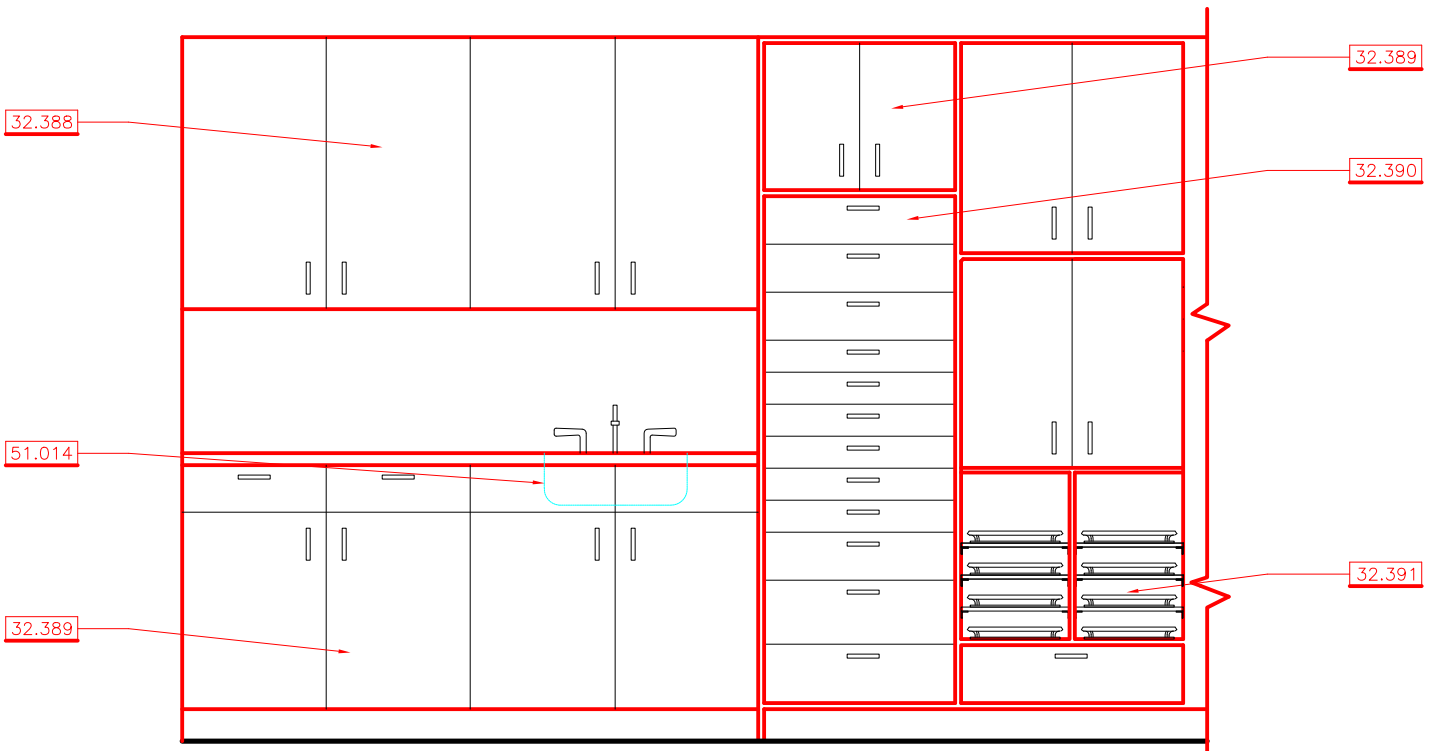

A Typical Room Storage Elevation 32.114 32.115 32.395 32.408

IDP1033

scale at:	1 = 25	0	2	4	6	8	10	12				
	1/2"=1'-0"	0	1	2	3	4	5	6	7	8	9	10
		000 Refer to the Varian Components chart at the end of this section.			General Room Storage Requirements Clinac Linear Accelerators							
Not For Construction												
1.30.0	:page	planning dept.	© Varian Medical Systems 2008 All rights reserved.			15Apr09	revision: 4	doc. #: 1100776	page: 1.30.0			

10 - General Notes

10.180

The information shown is for ALL Clinac linear accelerator models 2100C(D), 2300C(D), 21EX, 23EX, iX, Trilogy and Novalis Tx.

32 - Room Storage Casework

32.114

Bulk and shelf storage are required for Varian accessories and various materials used for therapy. The Varian-supplied Accessories include Electron Applicators (cones), Wedges, and other field-defining devices. Storage space in the treatment room should be planned to reduce travel required for patient set-up. Patient block tray storage should be located on the entrance side of the Treatment Couch. Linen storage in the treatment room and storage space for many patient positioning pads and devices is desirable.

32.115

Many spare parts are shipped with the equipment and an optional spare parts kit can be ordered. These will require secure storage in or near the treatment room.

32.388

Provide cabinets with adjustable shelves for linen storage..

32.389

Provide cabinets with adjustable shelves for general storage.

32.390

Provide drawers for general storage.

32.391

Provide Wedge Tray and Compensator Tray storage. Trays are accessories mounted to the Collimator that are used to shape the treatment field. They are usually stored on shelves as shown on the storage dimensions drawing. Due to their heavy weight, store them as near as possible to the Collimator and at accessible heights. Typical Clinac rooms require storage for 8 Wedge and Compensator Trays depending on the specific treatment objectives. Their maximum weight is 15 lbs. (7 kg) per tray.

32.392

Provide FFDA Storage (Dual Energy Clinacs and Acuity only). FFDAs are accessories mounted into the electron applicator to shape the electron treatment field. They are usually stored in drawers that are approximately 2"(50) deep by 2'-0"(610) wide. Due to their heavy weight, store them as near as possible to the Collimator and at accessible heights. Typical Clinac rooms require storage for 40 FFDAs. Typical Acuity rooms may require storage for 10 FFDAs. FFDA sizes vary from 4" X 4" (100 X 100) to 11" X 11" (280 X 280). The required number of drawers will vary with drawer size. Several 4"(100) deep drawers should also be provided.

32.393

Provide Block Tray storage. Block trays are accessories mounted to the Collimator that are used to shape the treatment field. They are custom made for each patient. They are usually stored in slots as shown on the storage dimensions drawing. Due to their heavy weight, store them as near as possible to the Collimator and at accessible heights. Typical Clinac rooms require storage for 50 to 100 Block Trays. This may vary with the use of the Multileaf Collimator. Typical Acuity rooms require storage for 10 Block Trays. Their maximum weight is 50 lbs. (23 kg) per tray.

32.394

Provide Electron Applicator Storage (Dual Energy Clinacs and Acuity only). Electron Applicators, otherwise known as "cones" are accessories mounted to the Collimator that are used in combination with FFDAs to shape the electron treatment field. They are usually stored in compartments with slots as shown on the storage dimensions drawing. Due to their heavy weight, store them as near as possible to the Collimator and at accessible heights. Typical Clinac rooms require storage for 6 Electron Applicators. Typical Acuity rooms in facilities that contain Dual Energy Clinacs may require storage for up to 6 Electron Applicators. Their maximum weight is 20 lbs. (9 kg) per applicator.

32.395

General Clinac room storage requirements are outlined below. This is only a partial list of storage items required for a typical Clinac room:
 > Treatment room furniture - chair, mirror, coat rack, foot stool, waste can, I.V. poles, oxygen bottle cart, film holder cart, soiled linen cart and total body irradiation "stage".
 > Miscellaneous storage items - spare parts, demineralized water, physics dosimetry equipment, film markers (letters), solder wire, restraints, "easy mover" stretchers, immobilization devices, patient shielding accessories, patient set-up accessories, patient marking accessories, arm/shoulder extenders, hand grips, breast boards and "alpha cradles (formed foam cradle).

32.408

The storage drawing shows a suggestion only of possible storage provisions and is intended as a guide to aid in the design of site specific casework. Due to differences in treatment practices, the exact quantity and types of accessories varies with each institution. Verify requirements and storage preferences with the Customer. This is not a construction document. All casework/storage shall be provided by the Customer.

51 - Plumbing

51.014

A sink with running hot and cold water is highly recommended in Clinac rooms. Appropriate codes should be followed regarding paddle or foot controls and type of faucet. A hose spigot is necessary to fill the water phantom and a drain is necessary to service the Clinac's internal cooling system and drain the water phantom. Floor drains and floor sinks should not be located in the room to avoid possible backup into the equipment floor recesses. Do not run water lines directly above the Clinac components or control console.

	[000] Refer to the Varian Components Chart at the end of this section.	General Room Storage Requirements Clinac Linear Accelerators			
	Not For Construction				
1.30.1 :page	planning dept.	© Varian Medical Systems 2008 All rights reserved.	15Apr09	revision: 4	doc. #: 1100776 page: 1.30.1

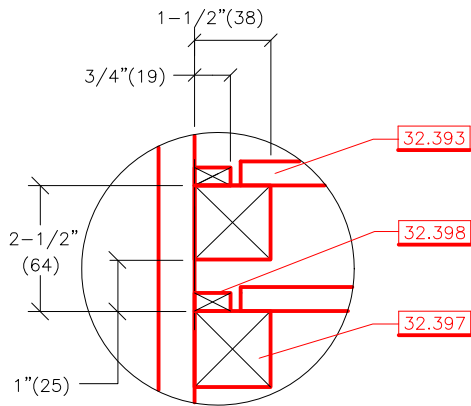

Detail 3

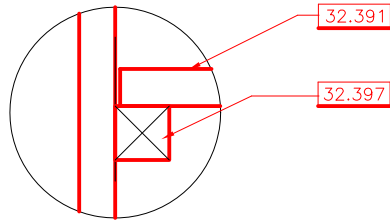

Detail 3

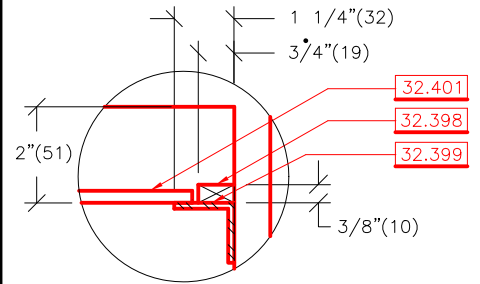

Detail 2

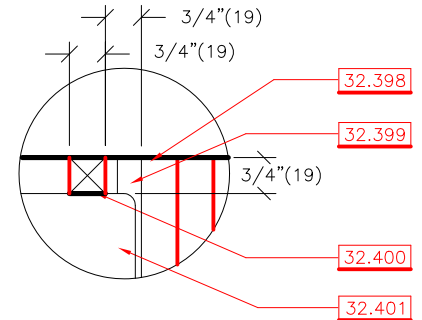

Detail 1

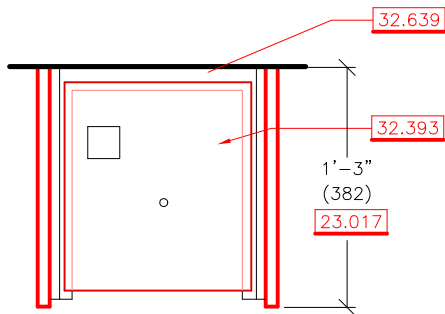

Plan View

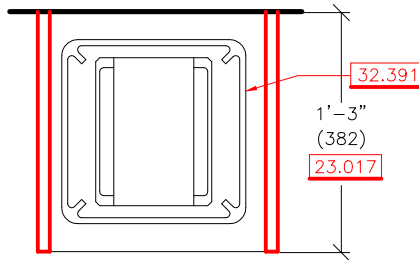

Plan View

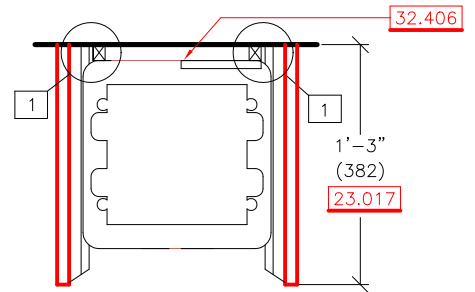

Plan View

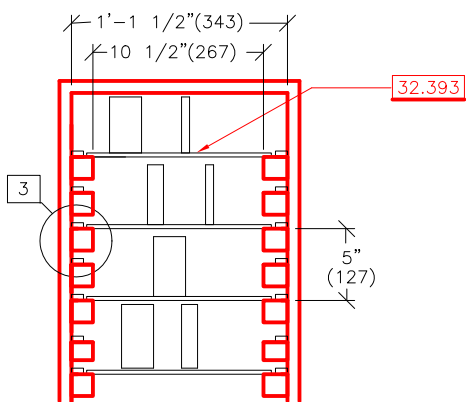

Elevation

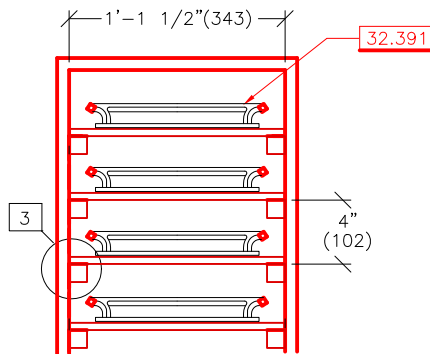

Elevation

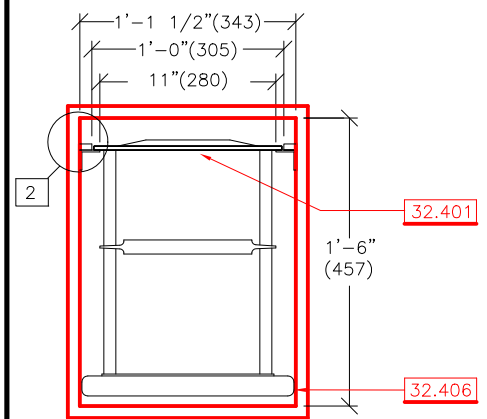

Elevation

C Block Storage	32.410	IDP1036	B Wedge Storage	32.410	IDP1035	A Applicator Storage	32.410	IDP1034
	32.393			32.391			32.394	

scale at:	1 = 12.5	0	.25	.5	.75	1	10.25	10.50			
	1"=1'-0"	0	.5	1	1.5	2	2.5	3	3.5	4	4.5

		Typical Accessory Storage Dimensions					
		Clinac Linear Accelerators					
1.31.0	:page	planning dept.	© Varian Medical Systems 2008 All rights reserved.	31Mar08	revision: 3	doc. #: 1100777	page: 1.31.0

10 - General Notes

10.180

The information shown is for ALL Clinac linear accelerator models 2100C(D), 2300C(D), 21EX, 23EX, iX, Trilogy and Novalis Tx.

23 - Dimension Descriptions

23.017

This is a minimum clear dimension.

32 - Room Storage Casework

32.391

Provide Wedge Tray and Compensator Tray storage. Trays are accessories mounted to the Collimator that are used to shape the treatment field. They are usually stored on shelves as shown on the storage dimensions drawing. Due to their heavy weight, store them as near as possible to the Collimator and at accessible heights. Typical Clinac rooms require storage for 8 Wedge and Compensator Trays depending on the specific treatment objectives. Their maximum weight is 15 lbs. (7 kg) per tray.

32.393

Provide Block Tray storage. Block trays are accessories mounted to the Collimator that are used to shape the treatment field. They are custom made for each patient. They are usually stored in slots as shown on the storage dimensions drawing. Due to their heavy weight, store them as near as possible to the Collimator and at accessible heights. Typical Clinac rooms require storage for 50 to 100 Block Trays. This may vary with the use of the Multileaf Collimator. Typical Acuity rooms require storage for 10 Block Trays. Their maximum weight is 50 lbs. (23 kg) per tray.

32.394

Provide Electron Applicator Storage (Dual Energy Clinacs and Acuity only). Electron Applicators, otherwise known as "cones" are accessories mounted to the Collimator that are used in combination with FFDA's to shape the electron treatment field. They are usually stored in compartments with slots as shown on the storage dimensions drawing. Due to their heavy weight, store them as near as possible to the Collimator and at accessible heights. Typical Clinac rooms require storage for 6 Electron Applicators. Typical Acuity rooms in facilities that contain Dual Energy Clinacs may require storage for up to 6 Electron Applicators. Their maximum weight is 20 lbs. (9 kg) per applicator.

32.397

Provide continuous wood support rails.

32.398

Provide a continuous wood stop.

32.399

Provide a continuous metal support angle.

32.400

Provide a wood stop at support rails (required for non-computerized equipment only)

32.401

The Electron Applicator is typically suspended by its metal support rail for storage.

32.406

This is the C-Series style Electron Applicator (sizes vary).

32.410

Provision should be considered for labeling Accessory Storage Compartments.

32.639

Due to the heavy weight of some block trays, a rear support rail is recommended.

	[000] Refer to the Varian Components Chart at the end of this section.	Typical Accessory Storage Dimensions Clinac Linear Accelerators				
	Not For Construction					
1.31.1 :page	planning dept.	© Varian Medical Systems 2008 All rights reserved.	31Mar08	revision: 3	doc. #: 1100777	page: 1.31.1

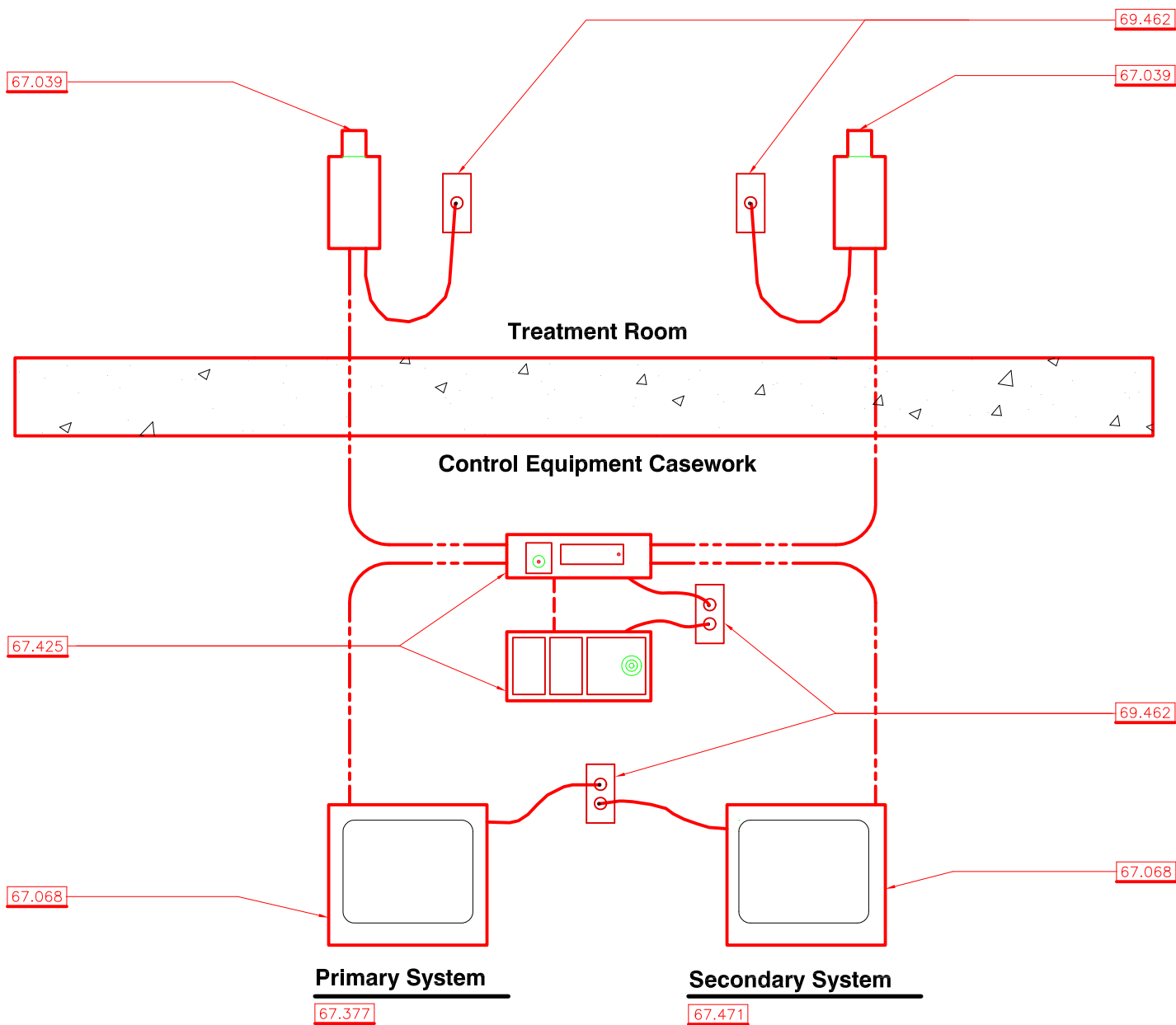

A Typical CCTV System Diagram 67.376

IDP1037

	000 Refer to the Varian Components chart at the end of this section.	Typical Closed Circuit Television (CCTV) System Clinac Linear Accelerators				
	Not For Construction					
1.32.0 :page	planning dept.	© Varian Medical Systems 2008 All rights reserved.	31Mar08	revision: 4	doc. #: 1100778	page: 1.32.0

10 - General Notes

10.180

The information shown is for ALL Clinac linear accelerator models 2100C(D), 2300C(D), 21EX, 23EX, iX, Trilogy and Novalis Tx.

67 - Communications

67.039

Provide one or two CCTV cameras in the room. The CCTV cameras are usually located approximately 15 degrees off each side of the equipment's longitudinal axis. Consult with the Customer for desired location. Provide a power receptacle and signal conduit from the control equipment area at each camera. Do not locate cameras in the primary beam path. Refer to the CCTV System manufacturer's literature for conduit, mounting and installation requirements.

67.068

CCTV monitors may be mounted on or under shelf and must be visible during treatment. The CCTV monitors must be located with patient privacy in mind. Monitors are often recessed in the control console casework and viewed through cut-outs covered with glass. Small, high-resolution monitors may be more exposed as the image is not clear from a distance. Provide a power receptacle for the monitors. Refer to the CCTV System manufacturer's literature for conduit, mounting and installation requirements. A non-interruptible power source may be required by regulatory code.

67.376

Not connected to the equipment, but required for Clinac operation and optional for Acuity rooms is a Closed-Circuit Television system. The CCTV System Diagram represents a typical installation only. The CCTV System components, cabling, power receptacles and conduit shall be supplied and installed by the Customer. In some circumstances, the CCTV System may be distributed by Varian at the Customer's option. Verify equipment ordered with Customer or Varian District Sales Manager.

67.377

A Primary CCTV System is mandatory for all Clinac vaults and required for Acuity rooms where the patient is visually isolated from the therapist at the control console. The CCTV System may be either monochrome or color. Verify selection of available options with Customer. The Primary CCTV System usually consists of the following devices:

- > CCTV Camera Assembly
 1. Camera Body
 2. Zoom Lens & Auto Iris
 3. Mounting Bracket
 4. Pan/Tilt Mechanism
- > Monitor Assembly
 1. Monitor
- > Camera Controls
 1. Zoom Lens Control
 2. Pan/Tilt Control
 3. Mounting Bracket

67.425

The CCTV System camera control units are located at the control equipment casework and require a power receptacle.

67.471

A Secondary CCTV System may be required by the Customer or regional regulatory agencies. This system is used as a backup and for alternate views. The system may be designed as shown in the CCTV System Diagram or may be a duplicate of the Primary System. The CCTV System may be either monochrome or color. Verify selection of available options with Customer. The Secondary CCTV System usually consists of the following devices:

- > CCTV Camera Assembly
 1. Camera Body
 2. Wide Angle Lens
 3. Mounting Bracket
- > Monitor Assembly
 1. Monitor

69 - Power Receptacles / Switches

69.462

Provide convenience electrical power receptacles as required.

VARIAN medical systems	[000] Refer to the Varian Components Chart at the end of this section.	Typical Closed Circuit Television (CCTV) System Clinac Linear Accelerators				
	Not For Construction					
1.32.1 :page	planning dept.	© Varian Medical Systems 2008 All rights reserved.	31Mar08	revision: 4	doc. #: 1100778	page: 1.32.1

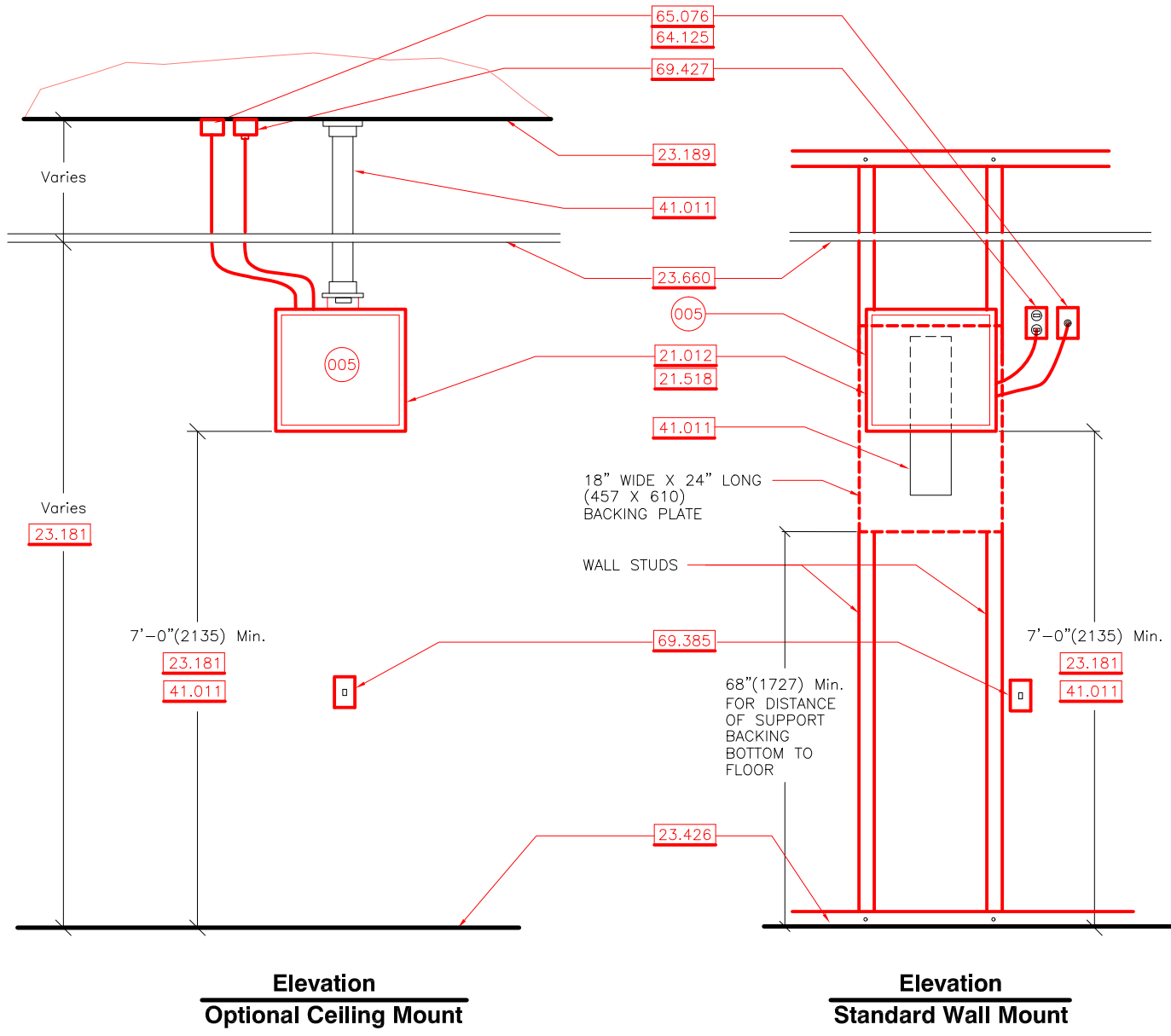

Elevation
Optional Ceiling Mount

Elevation
Standard Wall Mount

IDP1039

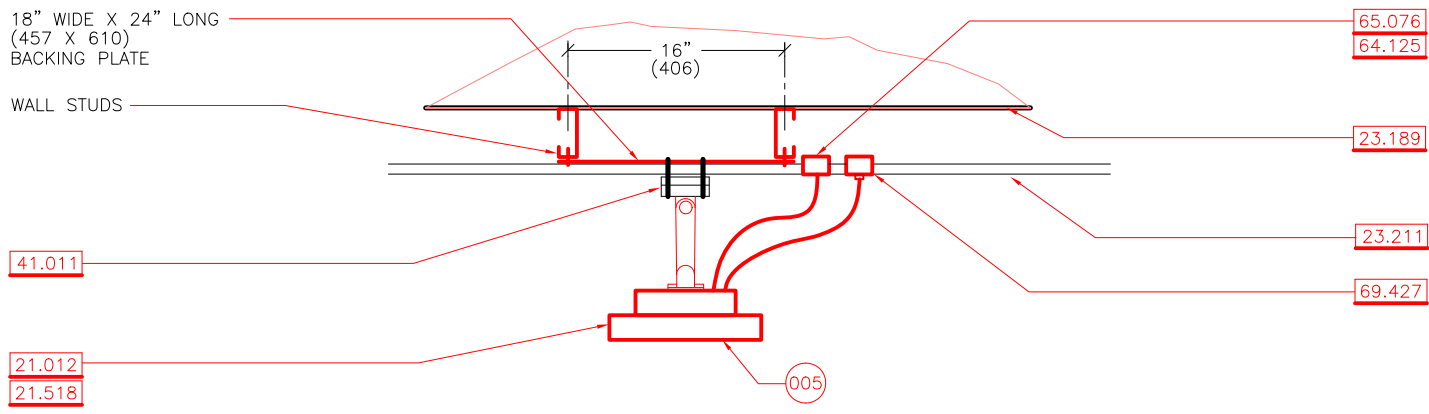

A Typical Plan

IDP1038

	(000) Refer to the Varian Components chart at the end of this section.	In-Room Monitor Clinac Linear Accelerators				
	Not For Construction					
1.33.0 :page	planning dept.	© Varian Medical Systems 2008 All rights reserved.	31Mar08	revision: 6	doc. #: 1100791	page: 1.33.0

10 - General Notes

10.180

The information shown is for ALL Clinac linear accelerator models 2100C(D), 2300C/D, 21EX, 23EX, iX, Trilogy and Novalis Tx.

21 - Equipment Layout / Clearances

21.012

The In-Room Monitor should be located where the operator can observe it without turning away from either the machine or patient on the couch. The monitor provides information during patient setup and it is unsafe to turn away from the patient while the machine is moving and the patient is on the couch. The In-Room Monitor may be mounted on a wall, ceiling, or shelf. Do not locate the In-Room Monitor in the primary beam path.

21.518

The Wall mounted In-Room Monitor is standard with the Clinac. The wall mount and monitor bracket are provided by Varian and shipped with the system. The Wall mount support backing is installed by the Contractor. The Wall mount is installed by the Contractor. Contact Varian's Planning Department for additional information on monitor bracket information.

23 - Dimension Descriptions

23.181

This is the recommended height above the finish floor.

23.189

This is the line of the shielding barrier.

23.211

This is the recommended dimension to concrete. Recommended face of concrete dimensions assume up to 6"(150) of wall furring.

23.426

This is the line of the finish floor.

23.660

This is the line of the suspended ceiling.

41 - Component Anchorage Brackets

41.011

If equipment is to be anchored to a wall or ceiling, provide structural backing and support (by Customer/Contractor). Install per bracket manufacturer's instructions. Verify mounting height with local codes. A Wall Mounting bracket is provided by Varian. Ceiling mounting or cabinet mounting is provided by Customer/Contractor. Contact Varian's Planning Department for additional information on ceiling mounting monitor brackets.

64 - Cable Access Runs

64.125

Provide one 2"(50) conduit between the pull box at In-Room Monitor and the pull box at Control Console. Depending on the configuration, up to four cables may need to be pulled through this conduit. The length of this cable run shall not exceed 75 feet (22,900).

65 - Pull / Junction Boxes

65.076

Provide a signal pull box for the In-Room Monitor. This is a standard computer signal cable outlet. If the signal cables are to be recessed, provide a signal outlet and conduits from the in-room monitor to the Control Equipment console.

69 - Power Receptacles / Switches

69.385

At locations where access to the In-Room Monitor is difficult, a switch may be installed in the room to control the power receptacle.

69.427

Provide an electrical power receptacle at the In-Room Monitor.

	[000] Refer to the Varian Components Chart at the end of this section.	In-Room Monitor Clinac Linear Accelerators				
	Not For Construction					
1.33.1 :page	planning dept.	© Varian Medical Systems 2008 All rights reserved.	31Mar08	revision: 6	doc. #: 1100791	page: 1.33.1

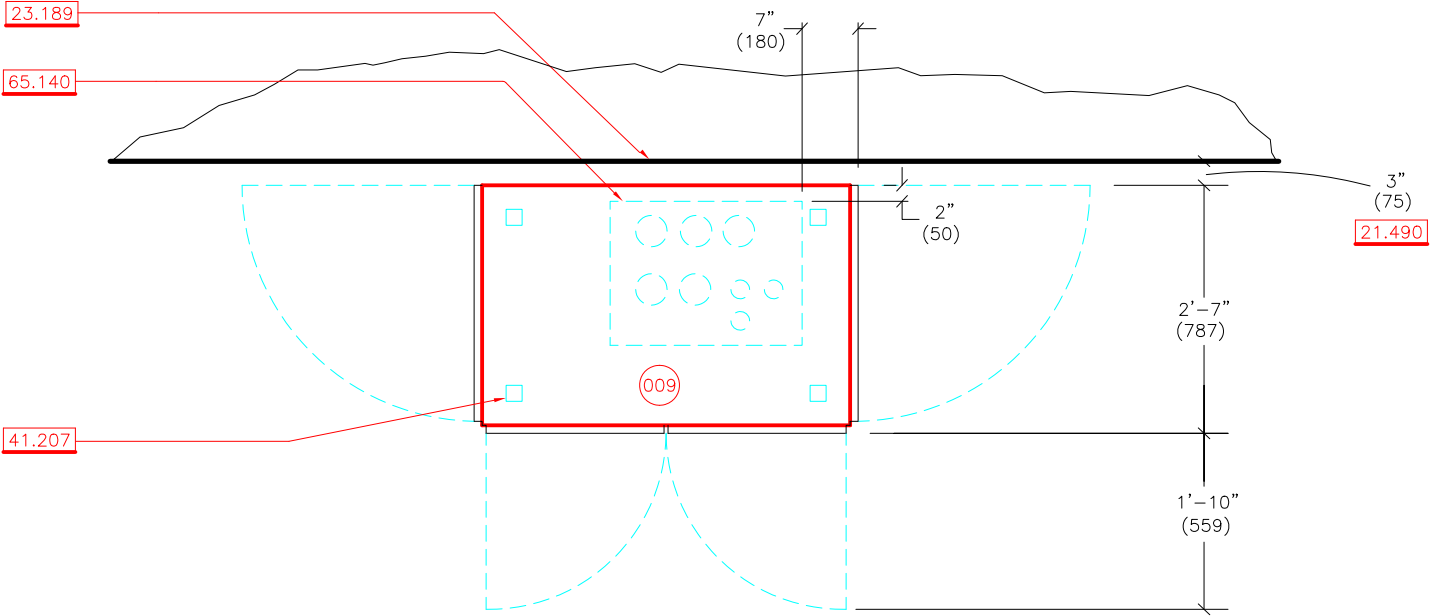

B Plan View 21.209

IDP1043

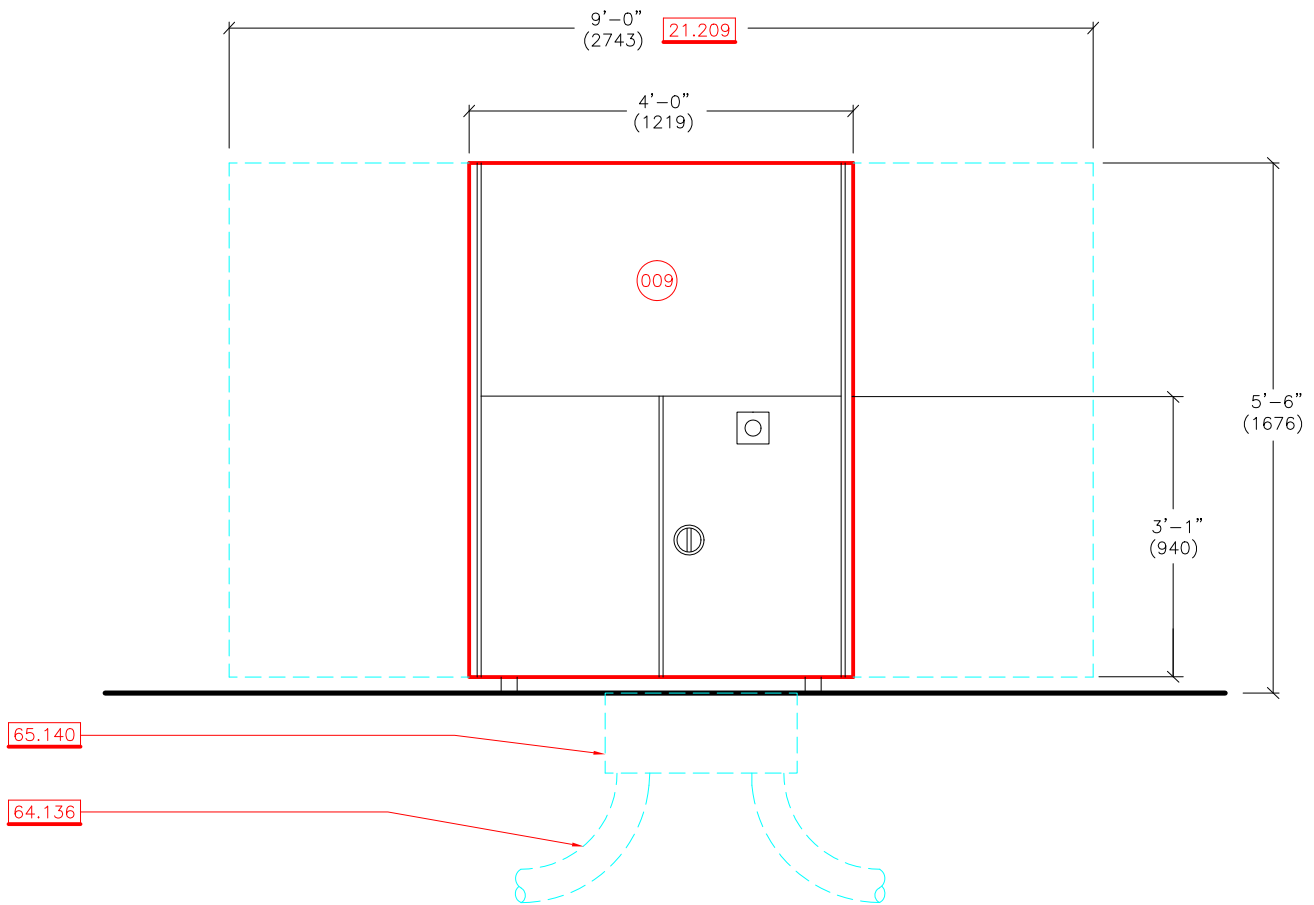

A Elevation View

IDP1042

scale at:	1 = 25	0	1	2	3	4	5	6
	1/2" = 1'-0"	0	1	2	3	4	5	6
	Refer to the Varian Components chart at the end of this section.	Modulator Cabinet Clinac Linear Accelerators						
		Not For Construction						
1.34.0	:page	planning dept.	© Varian Medical Systems 2008 All rights reserved.	31Mar08	revision: 6	doc. #: 861649	page: 1.34.0	

10 - General Notes

10.180

The information shown is for ALL Clinac linear accelerator models 2100C(D), 2300C/D, 21EX, 23EX, iX, Trilogy and Novalis Tx.

21 - Equipment Layout / Clearances

21.209

The Modulator Cabinet [009] may be located either in the Clinac room or remotely. Ventilation, acoustics, service provisions and cable length must be considered. The Modulator Cabinet has service panels at both sides and front. Provide 9'-0" (2750) clear space, side to side. If the Modulator Cabinet is located in a closet, verify local electronics cabinet clearance requirements with regional regulatory agencies. Do not locate this cabinet in the primary beam path.

21.490

Provide a minimum 3" (75) clearance behind the Modulator Cabinet for ventilation.

23 - Dimension Descriptions

23.189

This is the line of the shielding barrier.

41 - Component Anchorage Brackets

41.207

The Modulator Cabinet [009] rests on four equipment feet. If seismic anchorage is required, contact the Varian Planning Department for sample structural calculations. A seismic mounting kit is available (contact the regional Installation Project Manager to order a kit). This cabinet weighs approximately 1800 lbs. (816 kg).

64 - Cable Access Runs

64.136

The conduits may terminate anywhere within the pull box. See the Cable Access Diagram for quantity and size of conduits.

65 - Pull / Junction Boxes

65.140

The Modulator pull box is recessed into the floor slab and shall be 18" x 24" x 10" deep (450 x 600 x 250). Refer to the "Modulator Cabinet" drawing for pull box location. The cable access to this box shall be similar to Base Frame Cable Access Details.

	[000] Refer to the Varian Components Chart at the end of this section.	Modulator Cabinet Clinac Linear Accelerators				
	Not For Construction					
1.34.1 :page	planning dept.	© Varian Medical Systems 2008 All rights reserved.	31Mar08	revision: 6	doc. #: 861649	page: 1.34.1

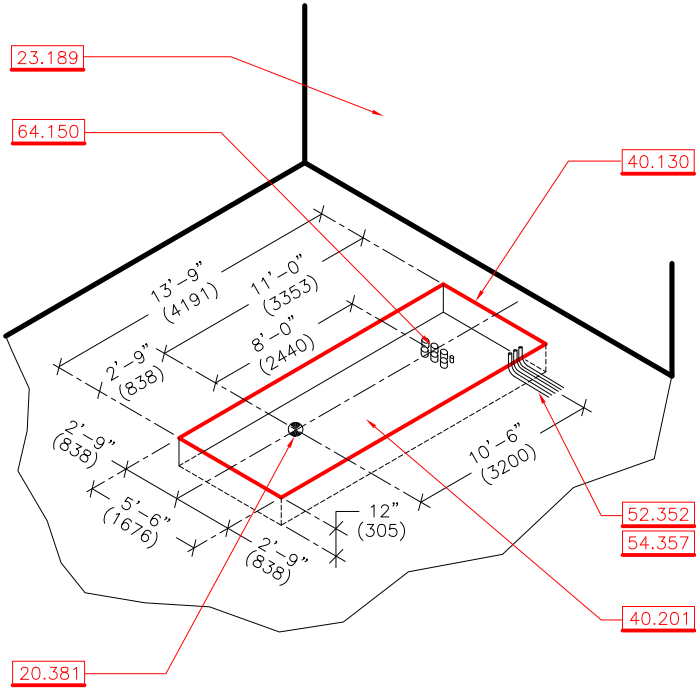

D Base Frame Pit Dimensions IDP1047

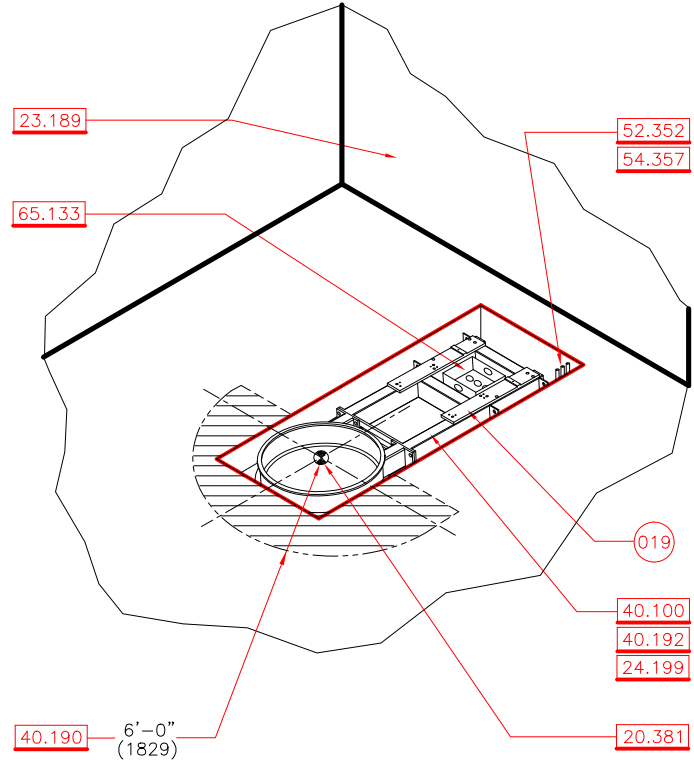

C Base Frame Installed IDP1068

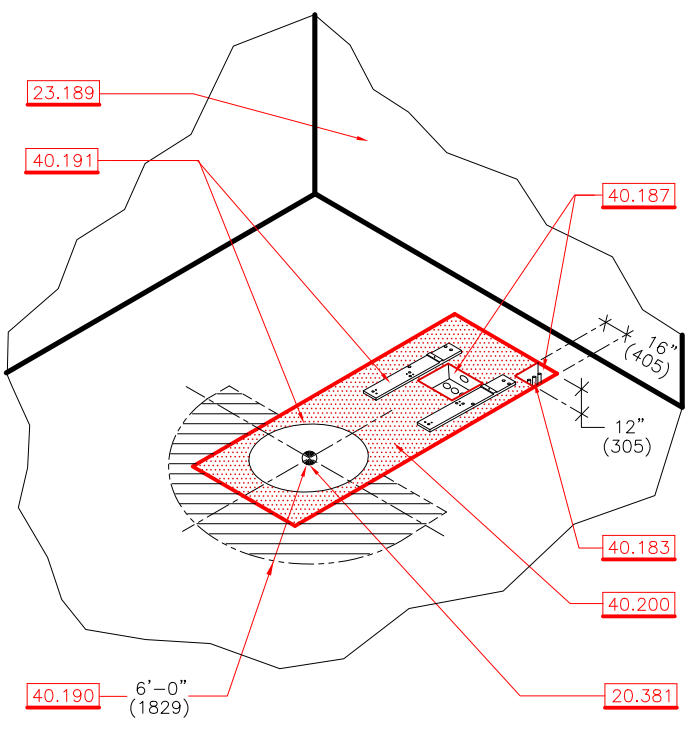

B Grout After Base Frame Installation IDP1045

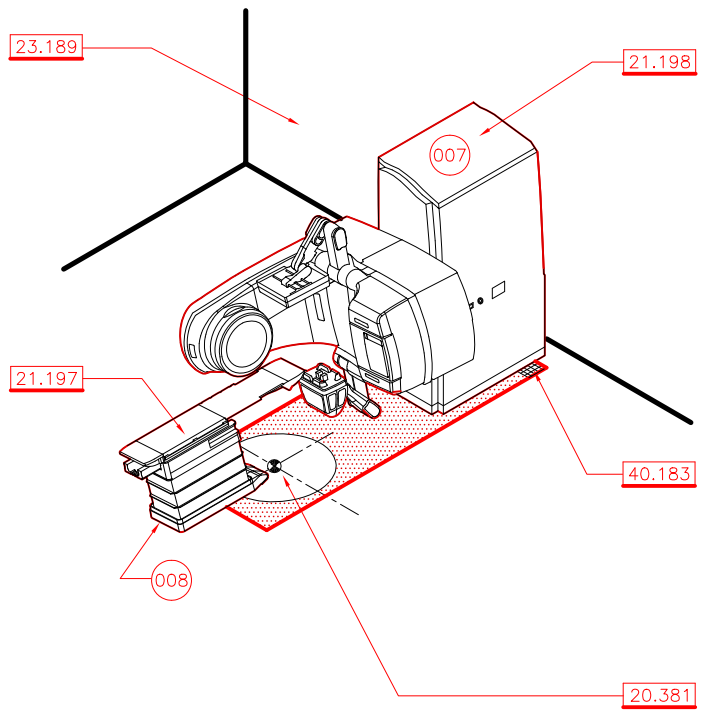

A Clinac Installed IDP1044

10 - General Notes

10.180

The information shown is for ALL Clinac linear accelerator models 2100C(D), 2300C(D), 21EX, 23EX, iX, Trilogy and Novalis Tx.

20 - General Layout Notes

20.381

Isocenter - This is the primary reference point for Varian equipment. Show the isocenter location clearly on all relevant drawings. Maintain the isocenter location on site by extending perpendicular axis lines along slab and up walls in all four directions. The isocenter heights for Clinac Linear Accelerator and Silhouette are as follows:

- > Standard Isocenter Height - 4'-3" (1295)
- > Optional lowered Isocenter - 4'-1" (1245)

21 - Equipment Layout / Clearances

21.197

The Treatment Couch is supplied by Varian and placed on Couch Turntable Assembly by the Customer (Rigger) under Varian supervision.

21.198

The Stand is supplied by Varian and placed on the Base Frame by the Customer (Rigger) under Varian supervision.

23 - Dimension Descriptions

23.189

This is the line of the shielding barrier.

24 - Installation Notes

24.199

The Base Frame shall be ordered at least three weeks prior to the required delivery date. Contact the Varian Installation Project Manager to schedule delivery.

30 - Finishes

30.024

As with most computer components, the electronic components for this equipment are sensitive to localized static electricity. Carpeting or other flooring adjacent to the equipment in the room or at the control equipment area should not exceed a 2.0 kV rating at 20% relative humidity when measured as outlined by the methods in AATCC-134. Retrofit static dissipative coatings are also available from various manufacturers. Carpet, while otherwise advantageous, can make gurney movement difficult. Floor stains are common due to the use of dyes to mark reference points on patients. Many facilities use carpet squares that can be replaced or cleaned and allow access to floor duct if used.

30.194

To avoid damage to the final floor covering, it may be installed after the equipment has been rigged onto the Base Frame and major assembly of the equipment has been completed. Coordinate floor covering and rigging with Installation Project Manager. Seal or "skim coat" the entire floor prior to machine delivery to eliminate dust and dirt.

40 - Base Frame Installation / Anchorage

40.100

A steel frame is used to anchor the Clinac Stand, Gantry and Couch to the facility. The frame is set in a recessed equipment pit, leveled (by Varian), and held in place with grout. Base Frames are positively anchored to the slab to avoid floating during grout placement. Verify anchorage details with your Installation Project Manager office. Varian information regarding pit design assumes a ground floor installation. Upper floor installations require a thorough review by a qualified structural engineer. In typical installations, Base Frames for Clinacs are not positively anchored sufficiently to accommodate seismic loads. All seismic anchoring is by the Customer. Sample seismic calculations and details of the preferred anchoring methods for Clinacs are available from the Planning Department.

40.130

This is the out line of Base Frame pit recess.

40.183

The air and coolant pipes terminate in the recess at the back of the pit. This recess shall be free of grout. Provide a removable cover over exposed portion of opening. Due to minor position adjustments during installation, establish the final cover dimension after the Clinac is in place.

40.187

This cavity shall be free of grout.

40.190

The floor shall be level with the top of the Treatment Couch bearing mount to within $\pm 1/8"$ (3) for 6'-0"(1829) radius about isocenter.

40.191

The Couch Turntable Assembly and Stand mounting pads shall be free of grout.

40.192

Placement of the Base Frame in pit and final positioning is done by the Customer (Rigger) under Varian supervision.

40.200

After Base Frame is in place and leveled, fill recess with grout (by Customer). For standard grout, provide a minimum seven days cure time prior to Equipment installation. Use normal weight grout - 147 lb./cu ft (2355 kg/cu m), 28 day strength of 2000 lb./sq. in (141 kg/sq. cm), 6"(152) to 7"(178) slump, 3/8"(10) maximum pea gravel aggregate size.

40.201

Verify slab, subgrade and moisture protection requirements. All exposed concrete shall be suitably sealed before the Base Frame arrives on site. Pit depth shall not vary more than 1/4" (6).

52 - Coolant System

52.352

Terminate cooling water supply and return lines at Base Frame pit with 1" female NPT valves and plugs. Refer to the Base Frame Pit and Installation drawing for termination location. Final connection from valves in Base Frame pit to valves in Clinac Stand will be installed by Customer/contractor using Varian provided hose kit during Clinac installation.

54 - Compressed Air System

54.357

Terminate 1/2" compressed air line at the Base Frame pit with 1/2" female NPT ball valve. Refer to the Base Frame Pit and Installation drawing for termination location. Final connection from valve in Base Frame pit to valve in Clinac Stand will be installed by Customer/contractor using Varian provided hose kit during Clinac installation.

64 - Cable Access Runs

64.150

Verification of appropriate utility and cable access is the responsibility of the Customer. Selection of the appropriate cable access method is determined by site-specific conditions and Customer preference. The standard bottom cable access details are appropriate for the majority of installations. Side access conduit details are included for installations with sub-floor clearances of at least 24"(610). Duct access details are included for installations with minimal subfloor clearance. All conduits or cable ducts must be suitably sealed and protected to keep them clean and dry.

65 - Pull / Junction Boxes

65.133

As no connections are made at this location, many regulatory agencies do not require a Base Frame pull box. If a pull box is not used, keep this area free of grout. If required, provide a 12" x 24" x 10" deep (300 x 600 x 250) Base Frame pull box. Top access is required and the box shall extend 1/2"(13) above concrete.

	[000] Refer to the Varian Components Chart at the end of this section.	Base Frame Pit and Installation Clinac Linear Accelerators				
	Not For Construction					
1.35.1 :page	planning dept.	© Varian Medical Systems 2008 All rights reserved.	31Mar08	revision: 9	doc. #: 861644	page: 1.35.1

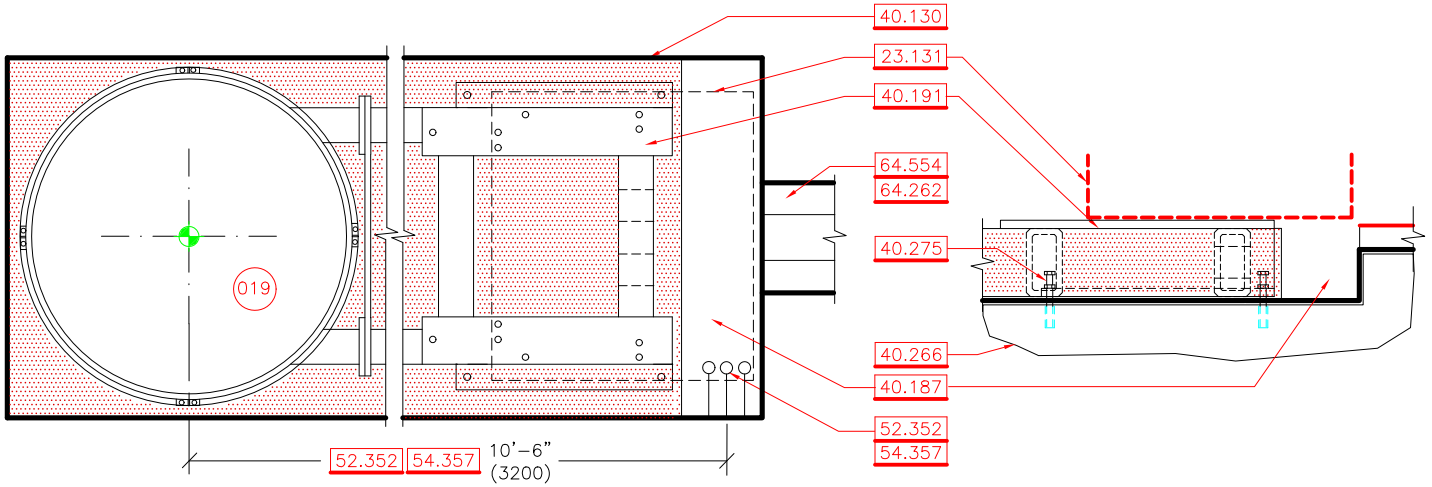

C Alternate Duct Cable Access Plan and Section at Pull Box 40.100 64.150

IDP1067

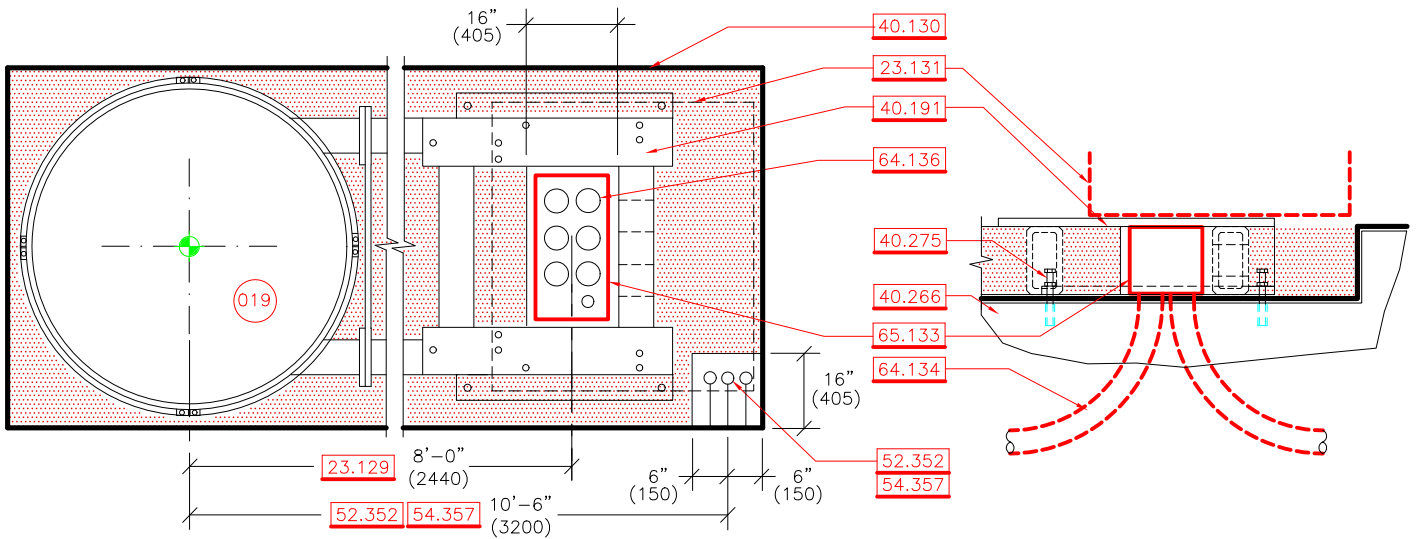

B Alternate Bottom Cable Access Plan and Section at Pull Box 40.100 64.150

IDP1065

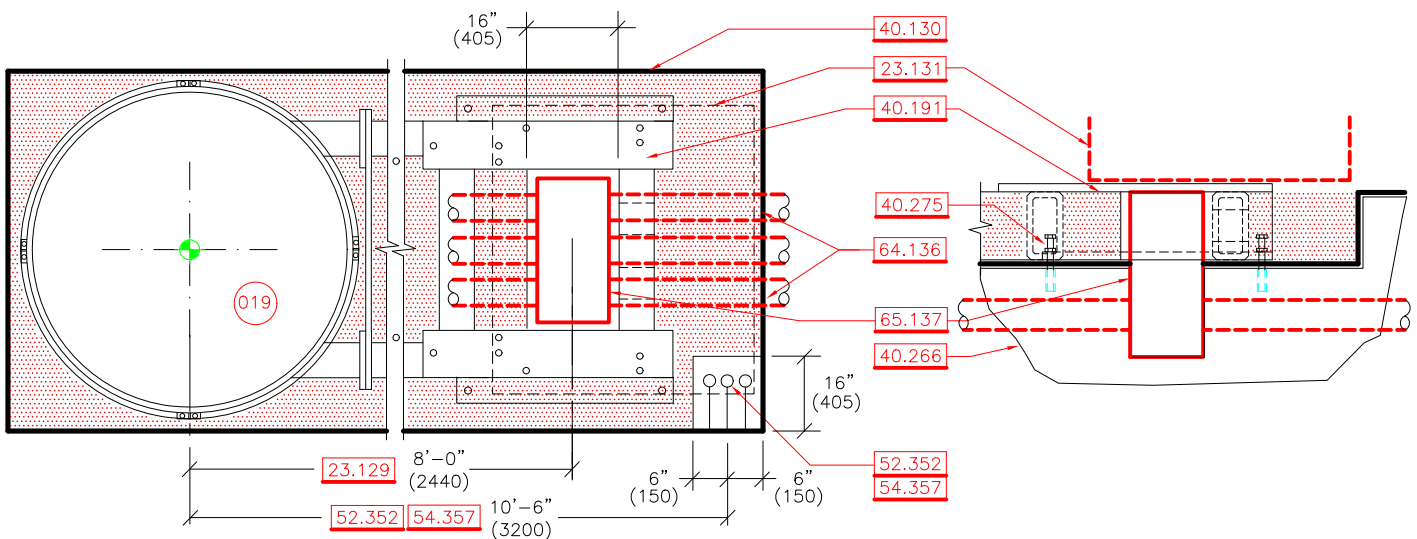

A Standard Side Cable Access Plan and Section at Pull Box 40.100 64.150

IDP1066

	000 Refer to the Varian Components chart at the end of this section.	Base Frame Cable Access Details Clinac Linear Accelerators			
	Not For Construction				
1.36.0 :page	planning dept.	© Varian Medical Systems 2008 All rights reserved.	20Jul09	revision: 7	doc. #: 1100737
					page: 1.36.0

10 - General Notes

10.180

The information shown is for ALL Clinac linear accelerator models 2100C(D), 2300C(D), 21EX, 23EX, iX, Trilogy and Novalis Tx.

23 - Dimension Descriptions

23.129

This is the isocenter to centerline of pull box dimension.

23.131

This is the out line of the equipment Stand.

40 - Base Frame Installation / Anchorage

40.100

A steel frame is used to anchor the Clinac Stand, Gantry and Couch to the facility. The frame is set in a recessed equipment pit, leveled (by Varian), and held in place with grout. Base Frames are positively anchored to the slab to avoid floating during grout placement. Verify anchorage details with your Installation Project Manager office. Varian information regarding pit design assumes a ground floor installation. Upper floor installations require a thorough review by a qualified structural engineer. In typical installations, Base Frames for Clinacs are not positively anchored sufficiently to accommodate seismic loads. All seismic anchoring is by the Customer. Sample seismic calculations and details of the preferred anchoring methods for Clinacs are available from the Planning Department.

40.130

This is the out line of Base Frame pit recess.

40.187

This cavity shall be free of grout.

40.191

The Couch Turntable Assembly and Stand mounting pads shall be free of grout.

40.266

Provide adequate reinforcing steel in slab.

40.275

Hold down anchor bolts are installed by Varian during the Base Frame installation. These bolts are used exclusively to avoid movement of the frame during grouting. They are not seismic attachment anchors.

52 - Coolant System

52.352

Terminate cooling water supply and return lines at Base Frame pit with 1" female NPT valves and plugs. Refer to the Base Frame Pit and Installation drawing for termination location. Final connection from valves in Base Frame pit to valves in Clinac Stand will be installed by Customer/contractor using Varian provided hose kit during Clinac installation.

54 - Compressed Air System

54.357

Terminate 1/2" compressed air line at the Base Frame pit with 1/2" female NPT ball valve. Refer to the Base Frame Pit and Installation drawing for termination location. Final connection from valve in Base Frame pit to valve in Clinac Stand will be installed by Customer/contractor using Varian provided hose kit during Clinac installation.

64 - Cable Access Runs

64.134

Provide adequate clearance for typical conduit radius of six times the diameter. Conduit bends shall not exceed 270 degrees per cable run. Route all room penetrations as perpendicular to the isocenter as possible to avoid radiation scatter. Verify all room penetrations with the Physicist of Record.

64.136

The conduits may terminate anywhere within the pull box. See the Cable Access Diagram for quantity and size of conduits.

64.150

Verification of appropriate utility and cable access is the responsibility of the Customer. Selection of the appropriate cable access method is determined by site-specific conditions and Customer preference. The standard bottom cable access details are appropriate for the majority of installations. Side access conduit details are included for installations with sub-floor clearances of at least 24"(610). Duct access details are included for installations with minimal subfloor clearance. All conduits or cable ducts must be suitably sealed and protected to keep them clean and dry.

64.262

Cable duct shall be installed and grounded per applicable electrical codes. Use standard, load bearing cable duct with removable cover.

64.554

For duct access situations, terminate a minimum 18" X 3" deep (450 X 75) floor duct with two partitions at the pull box.

65 - Pull / Junction Boxes

65.133

As no connections are made at this location, many regulatory agencies do not require a Base Frame pull box. If a pull box is not used, keep this area free of grout. If required, provide a 12" X 24" X 10" deep (300 X 600 X 250) Base Frame pull box. Top access is required and the box shall extend 1/2"(13) above concrete.

65.137

For side conduit access situations, provide a Base Frame pull box measuring 12" X 24" X 24" total depth (300 x 600 x 600). Provide a means to separate box at pit floor to prevent damage during Base Frame installation. Top access is required and the box shall extend 1/2"(13) above concrete. As no connections are made at this location, many regulatory agencies do not require the top box. If a pull box is not used, keep this area free of grout.

	[000] Refer to the Varian Components Chart at the end of this section.	Base Frame Cable Access Details Clinac Linear Accelerators				
	Not For Construction					
1.36.1 :page	planning dept.	© Varian Medical Systems 2008 All rights reserved.	20Jul09	revision: 7	doc. #: 1100737	page: 1.36.1

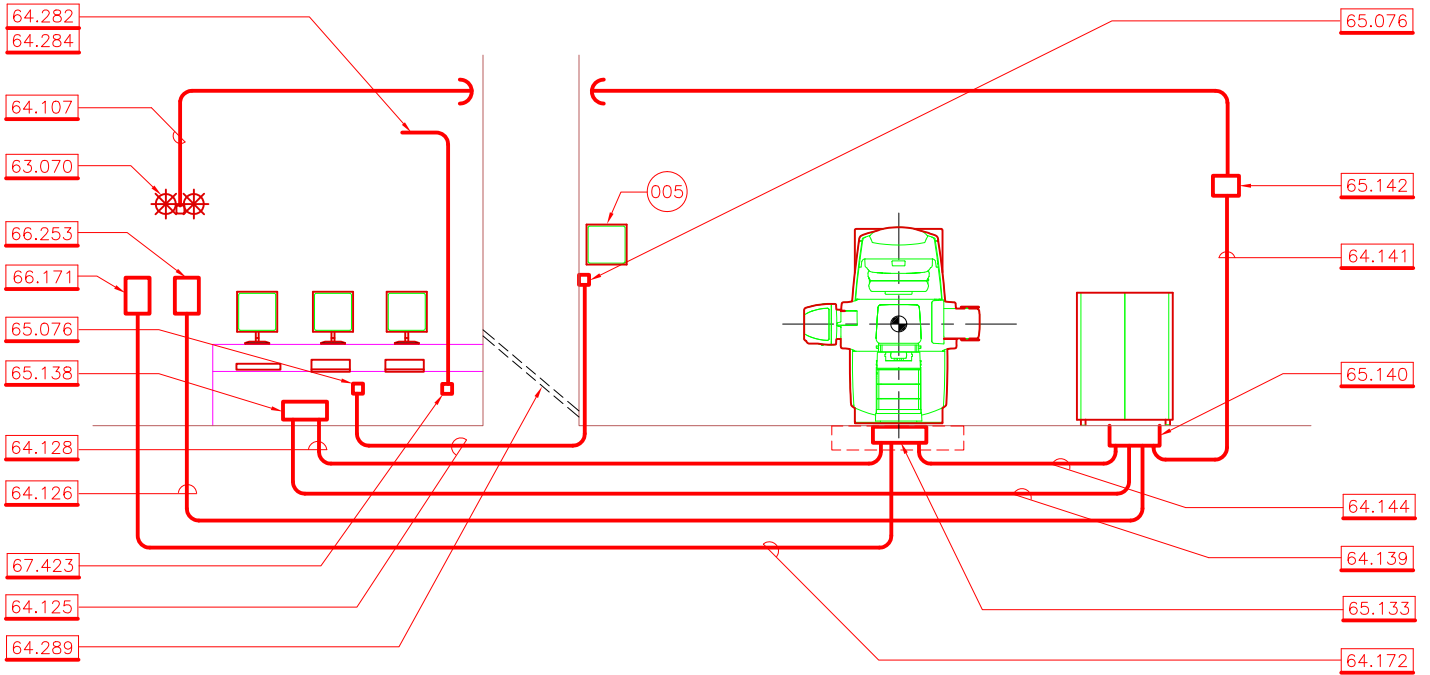

B Typical Conduit Riser

IDP1069

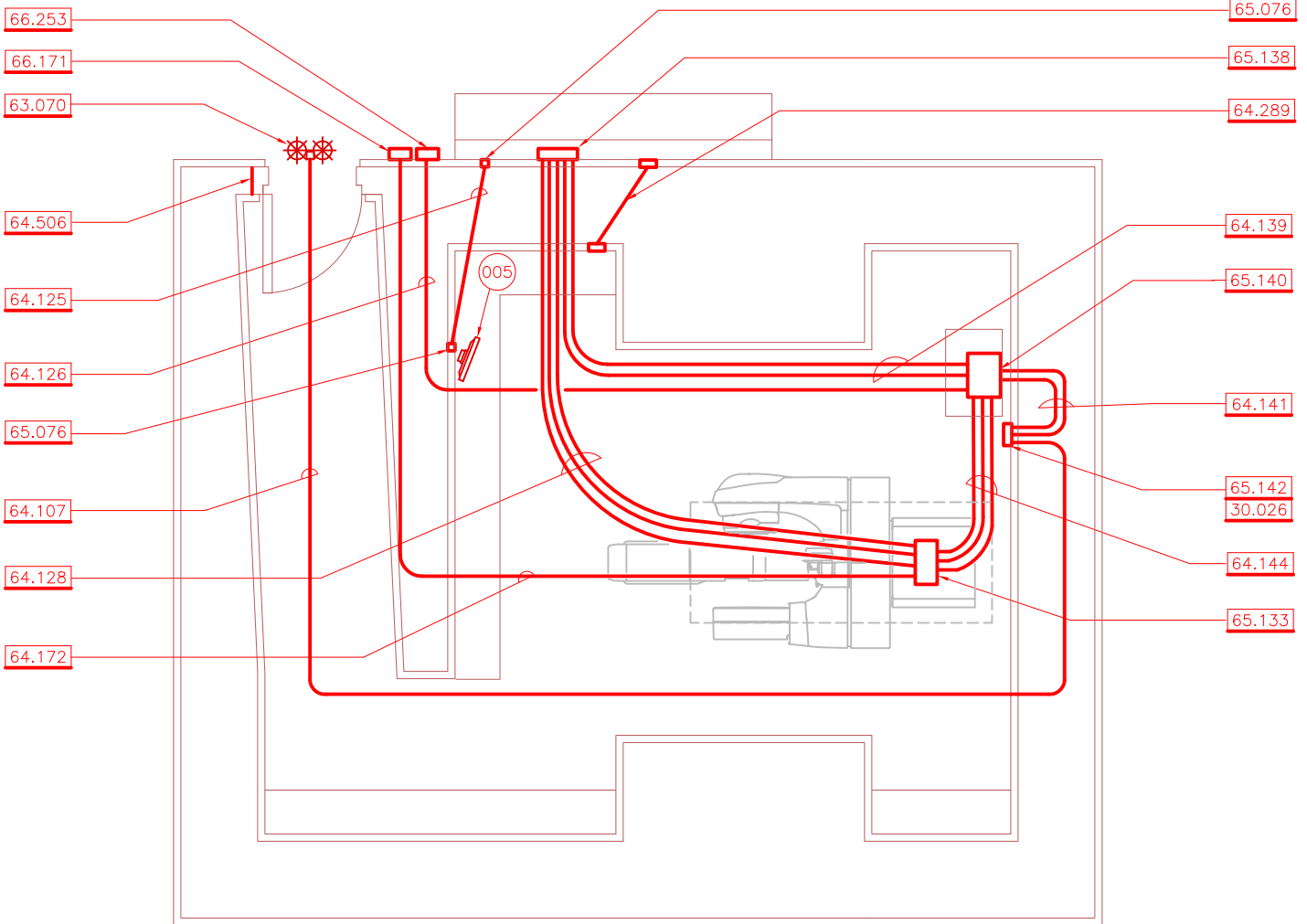

A Typical Cable Run Diagram 64.150 64.134

IDP1051

	(000) Refer to the Varian Components chart at the end of this section.	Cable Access Diagram Clinac Linear Accelerators			
	Not For Construction				
1.37.0 :page	planning dept.	© Varian Medical Systems 2008 All rights reserved.	15Sep08	revision: 6	doc. #: 1100738
					page: 1.37.0

10 - General Notes

10.180

The information shown is for ALL Clinac linear accelerator models 2100C(D), 2300C(D), 21EX, 23EX, iX, Trilogy and Novalis Tx.

30 - Finishes

30.026

Exposed grid ceilings allow for access to the overhead laser and Relay Junction Box without the use of access doors. Major service at the equipment Stand is simplified where there are removable ceiling tiles. Coordinate the layout of ceiling tile to insure that ceiling support system shall not interfere with overhead laser positioning light beam port.

63 - Safety Device Systems

63.070

Connections for two On Board Imager (OBI) warning lights, usually red colored, incandescent (no fluorescent lighting) are provided. Locate over the door, on the outside of the treatment room. They may be required to blink when the x-ray is on. Verify local requirements with regional regulatory agencies.

> "X-RAY ON" - OBI warning light

> "GENERATOR ON" - OBI warning light

Route Warning Light wiring to the Relay Junction Box.

64 - Cable Access Runs

64.107

Provide 1/2"(13) conduit between X-RAY warning light(s) and the Relay Junction Box.

64.125

Provide one 2"(50) conduit between the pull box at In-Room Monitor and the pull box at Control Console. Depending on the configuration, up to four cables may need to be pulled through this conduit. The length of this cable run shall not exceed 75'-0"(22,900).

64.126

Provide one 2"(50) conduit between Main Circuit Breaker Panel and Modulator pull box.

64.128

Provide three 4"(100) conduits between the Control Console pull box and the Base Frame pull box. The length of this cable run shall not exceed 75'-0"(22,900).

64.134

Provide adequate clearance for typical conduit radius of six times the diameter. Conduit bends shall not exceed 270 degrees per cable run. Route all room penetrations as perpendicular to the isocenter as possible to avoid radiation scatter. Verify all room penetrations with the Physicist of Record.

64.139

Provide two 4"(100) conduits between the Control Console pull box and the Modulator pull box. The length of this cable run shall not exceed 75'-0"(22,900).

64.141

Provide two 2"(50) conduits between the Relay Junction Box (RJB) and the Modulator pull box. The maximum conduit length from the RJB to the Modulator cannot exceed 45'-0" (13,716).

64.144

Provide three 4"(100) conduit between the Base Frame pull box and the Modulator pull box. The length of this cable run shall not exceed 75'-0"(22,900).

64.150

Verification of appropriate utility and cable access is the responsibility of the Customer. Selection of the appropriate cable access method is determined by site-specific conditions and Customer preference. The standard bottom cable access details are appropriate for the majority of installations. Side access conduit details are included for installations with sub-floor clearances of at least 24"(610). Duct access details are included for installations with minimal subfloor clearance. All conduits or cable ducts must be suitably sealed and protected to keep them clean and dry.

64.172

Provide one 2"(50) conduit between OBI Circuit Breaker panel and the Base Frame pull box.

64.282

Typical 1"(25) cable conduit.

64.284

Provide a 90 degree bend in conduit above wall to avoid damage to signal cables.

64.289

A 3"(75) experimental access (physics) conduit may be required by the Customer. The experimental access conduit is used to periodically monitor radiation in the equipment room. The conduit should be oriented as perpendicular to the isocenter as possible. Provide a locking 6" X 6" (150 X 150) access door at the conduit termination's. Review all vault penetrations with the Physicist of Record.

64.506

Provide two 4"(100) conduits tight to the ceiling, adjacent to the mechanical duct opening, to facilitate cable access for future room renovations. Review all vault penetrations with the Physicist of Record.

65 - Pull / Junction Boxes

65.076

Provide a signal pull box for the In-Room Monitor. This is a standard computer signal cable outlet. If the signal cables are to be recessed, provide a signal outlet and conduits from the in-room monitor to the Control Equipment console.

65.133

As no connections are made at this location, many regulatory agencies do not require a Base Frame pull box. If a pull box is not used, keep this area free of grout. If required, provide a 12" X 24" X 10" deep (300 X 600 X 250) Base Frame pull box. Top access is required and the box shall extend 1/2"(13) above concrete.

65.138

The Control Equipment pull box shall have a minimum size of 24" X 12" X 6" deep (610 X 300 X 150). This pull box may be wall mounted or accessed similar to details in Base Frame Cable Access Details. Locate this pull box so that the free ends of cables are protected from physical damage and located within 5'-0"(1525) of the Clinac Electronics Cabinet 003. As no connections are made at this location, many regulatory agencies do not require a pull box.

65.140

The Modulator pull box is recessed into the floor slab and shall be 18" X 24" X 10" deep (450 X 600 X 250). Refer to the "Modulator Cabinet" drawing for pull box location. The cable access to this box shall be similar to Base Frame Cable Access Details.

	[000] Refer to the Varian Components Chart at the end of this section.	Cable Access Diagram Clinac Linear Accelerators			
	Not For Construction				
1.37.1 :page	planning dept.	© Varian Medical Systems 2008 All rights reserved.	15Sep08	revision: 6	doc. #: 1100738 page: 1.37.1

65.142

The required Relay Junction Box (RJB) provides an interface with the Varian Clinac via a factory assembled and tested control panel designed to provide a convenient, organized, labor saving central connection point for the Laser positioning system, status warning lights, room lighting, door interlocks, and remote emergency off pushbuttons. The panel includes wiring diagrams to enable it to be used as a radial junction and control point simplifying the connection of the various systems. The Relay Junction Box can be located above finished ceiling (if accessible) or flush mounted to the wall, near the Clinac Modulator Cabinet. The maximum conduit length from the RJB to the Modulator cannot exceed 45'-0" (13,716).

The required Relay Junction Box is available from GEXPRO (800-200-9760 X3876 or 317-554-3876) Catalog #VRJB-C3 and ordering information is available from the Planning department web page: varian.com/architectural support or contact your regional Planning Manager.

66 - Circuit Breakers / UVRs**66.171**

The On-Board Imager Main Circuit Breaker Panel may be flush mounted on, or recessed in the wall. If recessed, provide a minimum 6"(150) thick wall. Locate within sight of and within 10'-0"(3050) of Clinac control equipment casework. Conspicuously identify as "Disconnect for OBI".

> Main Circuit Breaker Panel, recommended G.E. Catalog # OBI60A480V (includes 60A, 3-phase 400 - 480V circuit breaker, 60A, 480V contactor/120V coil installed in a Lockout/Tagout subpanel) or equivalent. The On-Board Imager Main Circuit Breaker Panel is available from GEXPRO (800-200-9760 X3876 or 317-554-3876) Catalog #OBI60A480V and ordering information is available from the Planning department web page: varian.com/architectural support or contact your regional Planning Manager.

66.253

The Main Circuit Breaker Panel may be flush mounted on, or recessed in, wall. If recessed, provide a minimum 6"(150) thick wall. Locate within sight of and within 10'-0"(3050) of Clinac control equipment casework.

67 - Communications**67.423**

Provide network cabling outlets at all server or workstations equipment locations. All network cabling and jacks must be minimum CAT5e. All network connections must operate at a minimum of 100 Mbit full duplex. TCP/IP data drops must be active at the time of installation. Network patch panels, hubs and routers are typically located in a server room or closet.

VARIAN medical systems	[000] Refer to the Varian Components Chart at the end of this section.	Cable Access Diagram			
	Not For Construction	Clinac Linear Accelerators			
1.37.2 :page	planning dept.	© Varian Medical Systems 2008 All rights reserved.	15Sep08	revision: 6	doc. #: 1100738 page: 1.37.2

- (R) 62.050
- (L) 61.111 61.042
- (S) 62.038
- (W) 63.049
- (N) 67.423
- (E) 63.057
- (T) 67.113
- (I) 63.294
- (I) 67.069
- (D) 63.297
- (M) 67.075
- (M) 63.297

B Legend 10.231

IDP1056

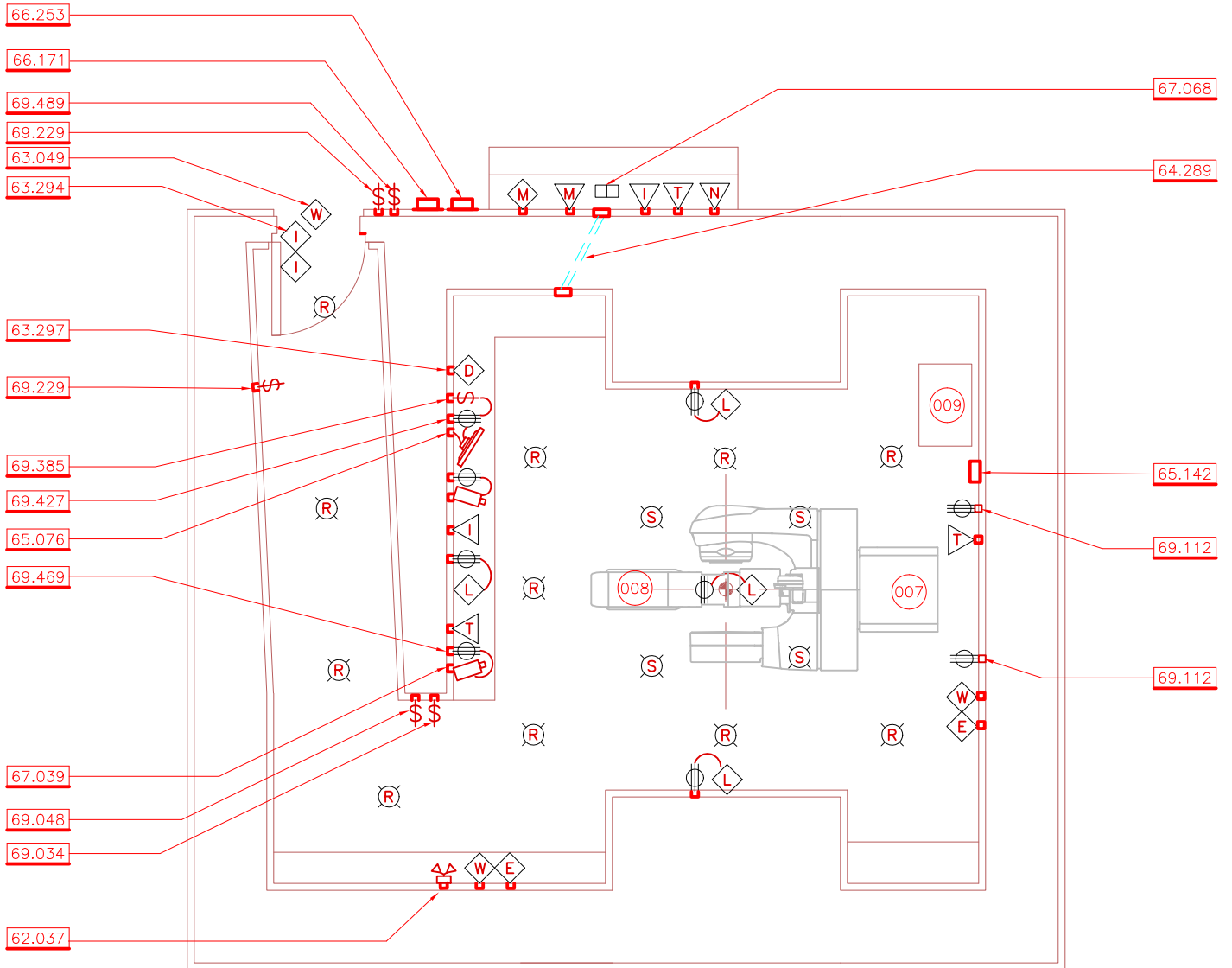

A Typical Room Plan 64.261 62.036

IDP1054

		Typical Lighting, Service and Safety Devices Clinac Linear Accelerators				
	Not For Construction					
1.38.0 :page	planning dept.	© Varian Medical Systems 2008 All rights reserved.	31Mar08	revision: 4	doc. #: 1100739	page: 1.38.0

10 - General Notes

10.180

The information shown is for ALL Clinac linear accelerator models 2100C(D), 2300C/D, 21EX, 23EX, iX, Trilogy and Novalis Tx.

10.231

Some of the equipment listed as "by Customer" may be purchased from Varian as a Customer option. Verify order with the Customer or Varian District Sales Manager.

61 - Laser Positioning Lights

61.042

The power to lasers is typically supplied by a grounded power receptacle at each laser location. A 3'-0"(900) power cord is provided with each laser. The receptacles are controlled through the Relay Junction Box as defined by the Interconnection Wiring Diagram. Route wiring to the Relay Junction Box.

61.111

The patient's position on the Couch is fixed by body markings that are aligned with "cross hairs" cast by the laser lights. Two wall laser positioning lights at isocenter height, a ceiling laser and the sagittal laser are powered by a common circuit controlled via the user interface in the Control Room or Couch Pendant or Couch Side Panels, through a relay. Lasers are usually distributed and installed, at the Customer's option, by Varian. The Customer is responsible for verification of laser types and mounting configurations.

62 - Room Lighting

62.036

The room lights, setup lights, laser positioning lights and Closed Circuit Television System(CCTV) can be controlled by a single room master switch, often outside the room and including a pilot light. The room lights can be on a separate circuit. Laser positioning lights control is automatically subordinated to room lights control on Clinacs and Acuity. A warning that lasers are on is implied when the room lights are off (lasers are turned off when room lights are on). The room lights and laser positioning lights may have wall switches inside the room, but this is not necessary when they are connected to the Relay Junction Box. Three-way switching is not recommended.

62.037

Consideration must be made for emergency lighting. Provide at least one fixture in the treatment room, one in the maze and one in the control equipment area.

62.038

Setup lights are normally dimmable incandescent fixtures, that allow the intensity to be adjusted by the therapists, while aligning the patient to the laser lights. The setup lights are usually located above and to either side of the longitudinal axis. The range of illumination for the setup lights is usually 25 to 40 foot-candles (269 to 431 meter-candles). Their operation is independent of the Pendant and Couch controls.

62.050

Main room lights are used for general illumination, while the patient is moving into and out of the room and for machine and room maintenance. This system normally uses fluorescent fixtures. The range of illumination for this activity is 75 to 100 foot-candles (807 to 1076 meter-candles) at the working level, approximately 3'-0"(915) above the floor. The fixtures are operated from the Clinac Couch and the Couch Pendant through a relay. If skylights and atria are used for general illumination, their contribution to the light level must be coordinated with the requirements during patient setup.

63 - Safety Device Systems

63.049

Provide beam-on warning lights in the treatment room, and over the door, or at eye level adjacent to the door outside the treatment room. Colored (usually red) lights usually must be placed such that one is visible from any point in a Clinac room. They are usually located adjacent to the emergency-off switches. They indicate beam-on condition and may be required to blink when the beam is on. Route Warning Light wiring to the Relay Junction Box. Verify local requirements with regional regulatory agencies.

63.057

Provide emergency-off switches in room (normally closed type, manual reset). In addition to the switches required as part of the room, emergency-off devices are built into the Clinac Stand and Couch, Console and at the Clinac Modulator. Adequate switches must be provided in Clinac rooms so that one need not pass through the primary beam to disable the Clinac. Do not locate emergency-off switches in primary beam. Locate switches to avoid inadvertent contact, such as by gurneys or carts. Route Emergency Off switch wiring to the Relay Junction Box. Verify all requirements with regional regulatory agencies.

63.294

Treatment Room safety door interlock switches are required for all installations. Provide for both 12 Vdc and 120/220 Vac door interlocks. They are normally open type switches and are used to ensure the room doors are closed during Clinac operation. Verify with the door manufacturer the type of switches supplied with the door or provide compatible type. Route interlock switches wiring to the Relay Junction Box.

63.297

An independent radiation detector and slave monitor with battery back-up is recommended. These can be supplied by Varian as an option. When purchased from Varian these items are surface mounted over a 3" X 3" X 1.5" (75 X 75 X 35) pull box located in the control console area and at the end of the treatment room maze. The maximum length of the cable run shall not exceed 100'-0"(30,480).

64 - Cable Access Runs

64.261

Except as noted, all conduits, pull boxes and junction boxes shall be supplied, sized and located by the Customer.

64.289

A 3"(75) experimental access (physics) conduit may be required by the Customer. The experimental access conduit is used to periodically monitor radiation in the equipment room. The conduit should be oriented as perpendicular to the isocenter as possible. Provide a locking 6" X 6" (150 X 150) access door at the conduit termination's. Review all vault penetrations with the Physicist of Record.

65 - Pull / Junction Boxes

65.076

Provide a signal pull box for the In-Room Monitor. This is a standard computer signal cable outlet. If the signal cables are to be recessed, provide a signal outlet and conduits from the in-room monitor to the Control Equipment console.

65.142

The required Relay Junction Box provides an interface with the Varian Clinac via a factory assembled and tested control panel designed to provide a convenient, organized, labor saving central connection point for the Laser positioning system, status warning lights, room lighting, door interlocks, and remote emergency off pushbuttons. The panel includes wiring diagrams to enable it to be used as a radial junction and control point simplifying the connection of the various systems. The Relay Junction Box can be located above finished ceiling (if accessible) or flush mounted to the wall, near the Clinac Modulator Cabinet.

The required Relay Junction Box is available from GEXPRO (800-200-9760 X3876 or 317-554-3876) Catalog #VRJB-C3 and ordering information is available from the Planning department web page: varian.com/architectural support or contact your regional Planning Manager.

	[000] Refer to the Varian Components Chart at the end of this section.	Typical Lighting, Service and Safety Devices Clinac Linear Accelerators			
	Not For Construction				
1.38.1 :page	© Varian Medical Systems 2008 All rights reserved.	31Mar08	revision: 4	doc. #: 1100739	page: 1.38.1
planning dept.					

66 - Circuit Breakers / UVRs

66.171

The On-Board Imager Main Circuit Breaker Panel may be flush mounted on, or recessed in the wall. If recessed, provide a minimum 6"(150) thick wall. Locate within sight of and within 10'-0"(3050) of Clinac control equipment casework. Conspicuously identify as "Disconnect for OBI".

> Main Circuit Breaker Panel, recommended G.E. Catalog # OBI60A480V (includes 60A, 3-phase 400 - 480V circuit breaker, 60A, 480V contactor/120V coil installed in a Lockout/Tagout subpanel) or equivalent. The On-Board Imager Main Circuit Breaker Panel is available from GEXPRO (800-200-9760 X3876 or 317-554-3876) Catalog #OBI60A480V and ordering information is available from the Planning department web page: varian.com/architectural support or contact your regional Planning Manager.

66.253

The Main Circuit Breaker Panel may be flush mounted on, or recessed in, wall. If recessed, provide a minimum 6"(150) thick wall. Locate within sight of and within 10'-0"(3050) of Clinac control equipment casework.

67 - Communications

67.039

Provide one or two CCTV cameras in the room. The CCTV cameras are usually located approximately 15 degrees off each side of the equipment's longitudinal axis. Consult with the Customer for desired location. Provide a power receptacle and signal conduit from the control equipment area at each camera. Do not locate cameras in the primary beam path. Refer to the CCTV System manufacturer's literature for conduit, mounting and installation requirements.

67.068

CCTV monitors may be mounted on or under shelf and must be visible during treatment. The CCTV monitors must be located with patient privacy in mind. Monitors are often recessed in the control console casework and viewed through cut-outs covered with glass. Small, high-resolution monitors may be more exposed as the image is not clear from a distance. Provide a power receptacle for the monitors. Refer to the CCTV System manufacturer's literature for conduit, mounting and installation requirements. A non- interruptible power source may be required by regulatory code.

67.069

Provide a two-way patient monitoring intercom system. The in-room intercom may be wall and/or ceiling mounted and should be voice-activated or continuous-on. The intercom at the control equipment area should be push-to-talk. Provide a signal conduit from the control equipment area and power to the intercom. Refer to the intercom manufacturer's literature for conduit, mounting and installation requirements. A non- interruptible power source may be required by regulatory code.

67.075

Provide an outside phone line for remote diagnostics modem. This line must be dedicated to data transmission and shall not go through a PBX or similar phone system.

67.113

Provide convenience phone jacks as required. A phone jack should be provided at any Varian equipment cabinet not located in the equipment room, near the equipment and within the control equipment casework. The phone system shall be operational prior to the equipment installation.

67.423

Provide network cabling outlets at all server or workstations equipment locations. All network cabling and jacks must be minimum CAT5e. All network connections must operate at a minimum of 100 Mbit full duplex. TCP/IP data drops must be active at the time of installation. Network patch panels, hubs and routers are typically located in a server room or closet.

69 - Power Receptacles / Switches

69.034

Provide a dimmer switch for set-up lights. This switch is used to adjust the illumination level of the set-up lights so that they are dim enough for clear visibility of the lasers, but bright enough for safe movement through the room.

69.048

A room lights switch is optional. The room lights are controlled through the Relay Junction Box. Route wiring to the Relay Junction Box.

69.112

A standard electrical outlet near the back of the accelerator, near the Modulator, and at convenient locations on the Control Console are required to service the equipment.

69.229

Door operator switches are required for Clinac installations with motorized doors. The in-room switch is typically located near the inside of the door. The outer switch should be located near, and in control of, the control equipment area. Provide electrical power for the door operator and coordinate the vault ceiling height at the door to clear the door operator hardware. Verify details with the door manufacturer.

69.427

Provide an electrical power receptacle at the In-Room Monitor.

69.469

Provide a power receptacle at each CCTV Camera.

69.489

A single room master switch can control the setup lights, laser positioning lights, closed circuit television system. It is often located outside the room and includes a pilot light.

	[000] Refer to the Varian Components Chart at the end of this section.	Typical Lighting, Service and Safety Devices Clinac Linear Accelerators			
	Not For Construction				
1.38.2 :page	© Varian Medical Systems 2008 All rights reserved.	31Mar08	revision: 4	doc. #: 1100739	page: 1.38.2

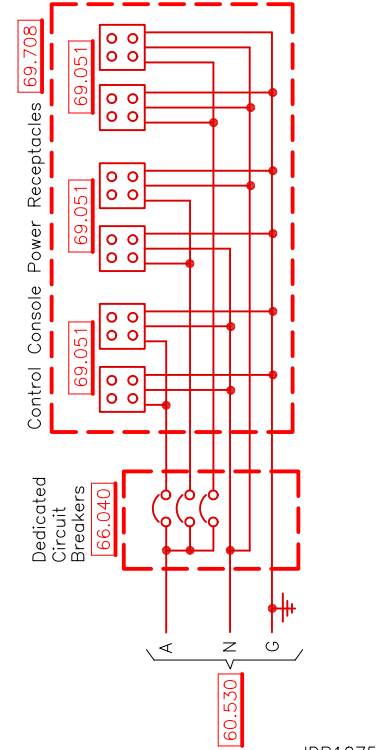
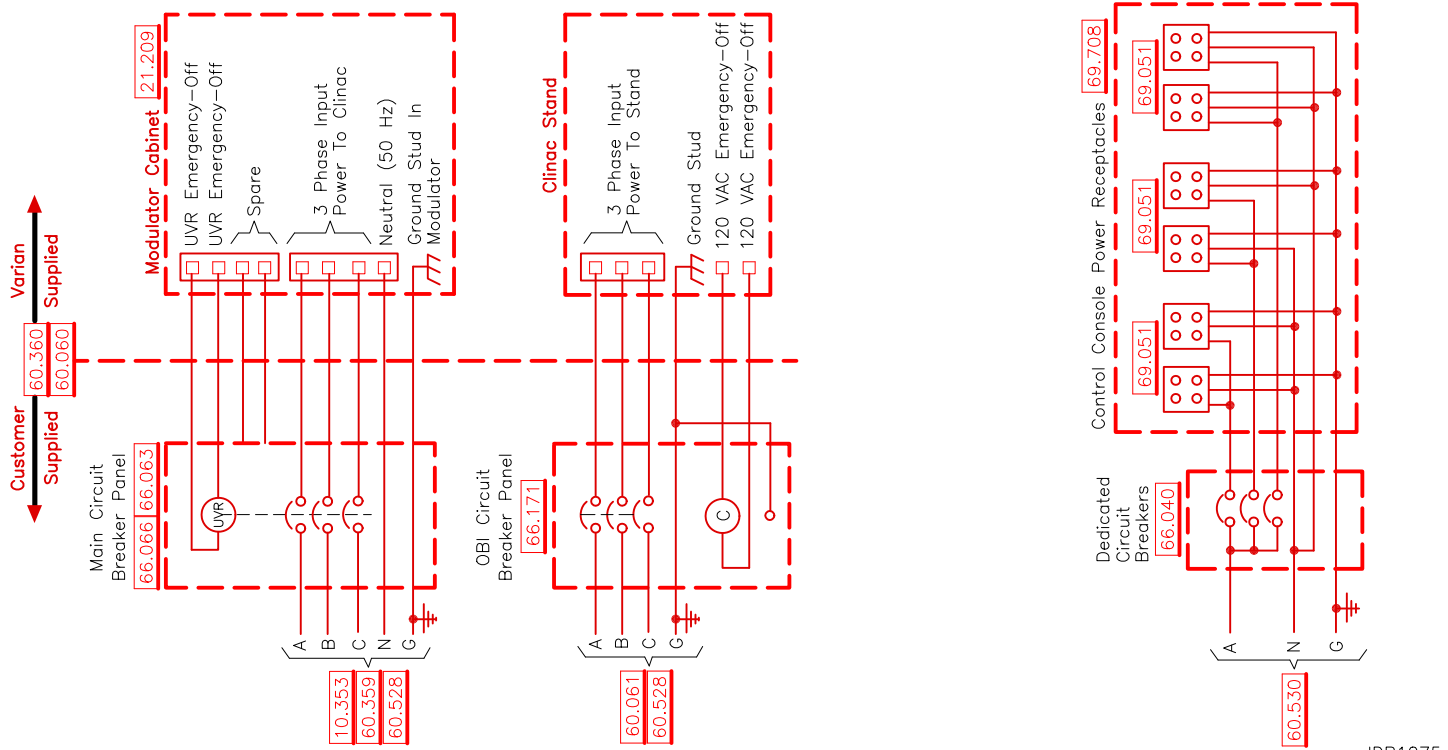
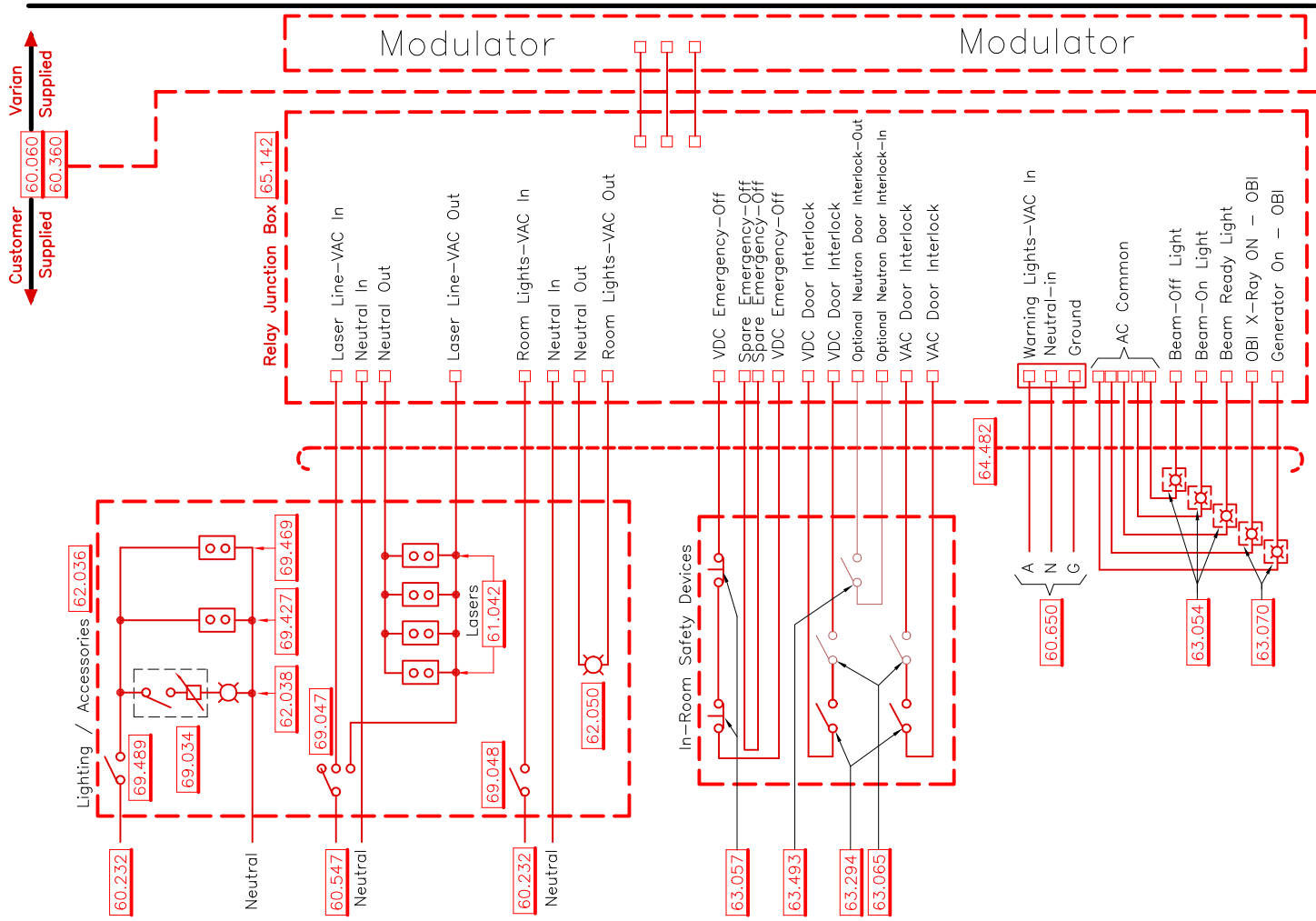

IDP1075



000 Refer to the Varian Components chart at the end of this section.

Not For Construction

**Interconnection Wiring Diagram
Clinac Linear Accelerators**

10 - General Notes

10.353

Use the following description of the Clinac operational states to determine the estimated utility load based on normal treatment cycles:

- > Standby - A condition usually in effect on weekends and overnight with only minimal electrical supplies operative, but with the water cooling system on.
- > Mode Release - A condition with no energy selected, all magnet and steering power supplies off, but with the klystron solenoid power supplies operative. Approximately 42 minutes per hour.
- > Ready/Energy Select - A condition with the Clinac ready to Beam-On. Approximately 6 minutes per hour.
- > Beam-On - The full-duty condition in which all primary heat sources operate at their maximum levels. Approximately 12 minutes per hour. The Beam-On State is maintained continuously for one hour or more during physics and calibration use.
- > The estimated number of minutes per hour of each state is based on an average of six patients treated per hour.

21 - Equipment Layout / Clearances

21.209

The Modulator Cabinet 009 may be located either in the Clinac room or remotely. Ventilation, acoustics, service provisions and cable length must be considered. The Modulator Cabinet has service panels at both sides and front. Provide 9'-0" (2750) clear space, side to side. If the Modulator Cabinet is located in a closet, verify local electronics cabinet clearance requirements with regional regulatory agencies. Do not locate this cabinet in the primary beam path.

60 - General Electrical Specifications

60.060

The Customer shall provide all wiring and components shown on the left side of the terminal blocks. The DC voltage terminal block accepts 14 AWG or smaller wire. The TB-1 terminal block accepts 2/0 AWG or smaller wire. Varian shall provide all circuits to the right of the terminal blocks. The Varian-provided control interconnect cables are not shown on this drawing. Label customer supplied wiring per terminal block connection.

60.061

On- Board Imager option Power Requirements

- > Input voltage - 400 to 480 Vac ($\pm 10\%$) 4 wire, 3-phase and ground.
- > Input frequency - 50 or 60 Hz $\pm 1\%$
- > Maximum phase voltage imbalance not to exceed 2% of the nominal value. This is the maximum difference between any two-phase voltages when operating at full load.
- > The maximum allowable momentary line voltage variation due to causes other than the x-ray equipment load shall not exceed $\pm 2.5\%$.
- > Maximum input impedance: 0.10 Ohm at 400 to 480 Vac.
- > Power On/Quiescence state - 1.0 kVA.
- > Supply capacity - 60 kVA.
- > Ground equipment through the "Hospital grid system" (The equipment is sensitive to electrolysis from water pipe grounding). Do not use water supply piping for grounding!
- > A grounding copper cable, minimum conductor size of not less than 2 AWG (35mm²), originating at the hospital main ground.

60.232

Provide 120 Vac (typical 60Hz) or 240 Vac (typical 50Hz) power for lighting and accessories circuits. 277 Vac lighting is acceptable, but will require a separate laser positioning light circuit. Lighting, lasers, and In-Room monitor may be on separate circuits.

60.359

Clinac Linear Accelerator or Silhouette Equipment Power Requirements

- > Input voltage - Typical 60hz- 200 to 240 Vac, line-to-line, 4 wire, 3-phase and ground.
- > Input voltage - Typical 50hz- 360 to 440 Vac, line-to-line, 5 wire, 3-phase, neutral and ground.
- > Line voltage regulation - $\pm 5\%$. This is the maximum allowable steady-state deviation from nominal value selected.
- > Maximum phase voltage imbalance - 3% of the nominal value. This is the maximum difference between any two phase voltages when operating at full load (Beam-On).
- > Input frequency - 50 or 60 Hz ± 1 Hz
- > Electrical loads - 3kVA in Stand-By state, 20kVA in Ready state and 45kVA in Beam-On state.
- > Long-Time Load - 45kVA. This is the maximum load that the source is expected to sustain during normal (Beam-On) operation; that is, during treatment. It must also be capable of sustaining this load occasionally for much longer periods of test and calibration.
- > Power factor - Estimated to be 90% or more. Most of the load is inductive. The line-current waveform is non-sinusoidal.
- > Source impedance - 2.5% maximum. This maximum recommendation is based on the minimum required source capacity; namely, 45kVA. At 208 Vac, this corresponds to 125A full load current. The recommended maximum impedance is therefore 24mOhm. At 400 Vac, the full load current is 65A and the recommended maximum impedance is 89mOhm. No minimum is specified, however, the fault current available shall not exceed 10,000A.
- > A separate grounding conductor is required. The minimum ground conductor size shall be 4 AWG. Ground equipment through the "Hospital Grid System". The equipment is sensitive to electrolysis from water pipe grounding. Do not use water supply piping for ground.

60.360

Clinac Linear Accelerator or Silhouette

. Electrical Connections - The Customer shall:(under Varian supervision)

- > Make all connections of Primary Power per the Interconnection Wiring Diagram.
- > Make all connections to the Relay Junction Box per the Interconnection Wiring Diagram.
- > Review connections and equipment function with the Varian Installer.
- > Route all system power from an isolated power source through the Main Circuit Breaker Panel.
- > Supply and connect phase, ground and (50 hz - neutral) power supply wires.
- > Supply and connect wiring for Under Voltage Relay, Beam-On Lights, Door Interlocks, Emergency-Off Switches, Laser Positioning lights and Room Lights.
- > Bundle all wiring in conduits shared by Varian cables.
- > Pull Varian-supplied cables per the following information:
 - > Three cables from the Modulator to the Console.
 - > Seven cables from the Console to the Base Frame.
 - > Ten cables from the Base Frame to the Modulator.

	[000] Refer to the Varian Components Chart at the end of this section.	Interconnection Wiring Diagram Clinac Linear Accelerators			
	Not For Construction				
1.39.1 :page	planning dept.	© Varian Medical Systems 2008 All rights reserved.	17Jul09	revision: 1	doc. #: 200074 page: 1.39.1

60.528**Power Conditioning Requirements**

> The equipment is sensitive to line voltage variations and source impedance. A complete survey of the electrical supply should be conducted prior to the equipment installation and a copy of this survey should be sent to the regional Installation Project Manager for the equipment file. Isolation transformers and/or power conditioners are required where the electrical power requirements specified herein cannot be met.

> Caution should be taken when powering the x-ray equipment from the same distribution source such as elevators, HVAC equipment and other phase controlled loads, because of potential adverse effects on the operation of the x-ray equipment. The supply voltage wave form should be practically sinusoidal with less than 5% total harmonic distortion. Signals from devices that use the power line as a means of distribution can be the source of problems, and efforts should be taken to minimize such effects.

> Transients lasting no more than a few cycles will not cause harm if limited to the specified steady state line voltage regulation. Transient suppression is required where larger, longer lasting or frequent transients occur as these can cause interruption of operation and/or equipment damage.

60.530

Provide 120 Vac (typical 60Hz) or 240 Vac (typical 50Hz) power.

60.547

Provide 120 Vac (typical 60Hz) or 240 Vac (typical 50Hz) 20 amp maximum, for the treatment room Lasers. Route wiring to the Relay Junction Box.

60.650

Provide 120 Vac (typical 60Hz) or 240 Vac (typical 50Hz) 20 amps maximum, power for the Warning Lights. Route wiring to the Relay Junction Box.

61 - Laser Positioning Lights**61.042**

The power to lasers is typically supplied by a grounded power receptacle at each laser location. A 3'-0"(900) power cord is provided with each laser. The receptacles are controlled through the Relay Junction Box as defined by the Interconnection Wiring Diagram. Route wiring to the Relay Junction Box.

62 - Room Lighting**62.036**

The room lights, setup lights, laser positioning lights and Closed Circuit Television System(CCTV) can be controlled by a single room master switch, often outside the room and including a pilot light. The room lights can be on a separate circuit. Laser positioning lights control is automatically subordinated to room lights control on Clinacs and Acuity. A warning that lasers are on is implied when the room lights are off (lasers are turned off when room lights are on). The room lights and laser positioning lights may have wall switches inside the room, but this is not necessary when they are connected to the Relay Junction Box. Three-way switching is not recommended.

62.038

Setup lights are normally dimmable incandescent fixtures, that allow the intensity to be adjusted by the therapists, while aligning the patient to the laser lights. The setup lights are usually located above and to either side of the longitudinal axis. The range of illumination for the setup lights is usually 25 to 40 foot-candles (269 to 431 meter-candles). Their operation is independent of the Pendant and Couch controls.

62.050

Main room lights are used for general illumination, while the patient is moving into and out of the room and for machine and room maintenance. This system normally uses fluorescent fixtures. The range of illumination for this activity is 75 to 100 foot-candles (807 to 1076 meter-candles) at the working level, approximately 3'-0"(915) above the floor. The fixtures are operated from the Clinac Couch and the Couch Pendant through a relay. If skylights and atria are used for general illumination, their contribution to the light level must be coordinated with the requirements during patient setup.

63 - Safety Device Systems**63.049**

Provide beam-on warning lights in the treatment room, and over the door, or at eye level adjacent to the door outside the treatment room. Colored (usually red) lights usually must be placed such that one is visible from any point in a Clinac room. They are usually located adjacent to the emergency-off switches. They indicate beam-on condition and may be required to blink when the beam is on. Route Warning Light wiring to the Relay Junction Box. Verify local requirements with regional regulatory agencies.

63.053

A ready light in the room and/or over the door may be required. Route Warning Light wiring to the Relay Junction Box. Verify local requirements with regional regulatory agencies.

63.054

Connections for three Clinac warning lights, usually red colored, incandescent (no fluorescent lighting) are provided. Locate over/near the door, on the outside of the treatment room. They may be required to blink when the x-ray is on. Verify local requirements with regional regulatory agencies.

> "BEAM - ON" - warning light

> "BEAM OFF" - warning light

> "READY" - warning light

The maximum incandescent lamp load is 60 watts per warning light. If a greater load is required, use these circuits to control a larger relay. Route Warning Light wiring to the Relay Junction Box.

63.057

Provide emergency-off switches in room (normally closed type, manual reset). In addition to the switches required as part of the room, emergency-off devices are built into the Clinac Stand and Couch, Console and at the Clinac Modulator. Adequate switches must be provided in Clinac rooms so that one need not pass through the primary beam to disable the Clinac. Do not locate emergency-off switches in primary beam. Locate switches to avoid inadvertent contact, such as by gurneys or carts. Route Emergency Off switch wiring to the Relay Junction Box. Verify all requirements with regional regulatory agencies.

63.065

The second door interlock switches are shown for paired entry doors. Route interlock switches wiring to the Relay Junction Box.

63.070

Connections for two On Board Imager (OBI) warning lights, usually red colored, incandescent (no fluorescent lighting) are provided.

Locate over the door, on the outside of the treatment room. They may be required to blink when the x-ray is on. Verify local requirements with regional regulatory agencies.

> "X-RAY ON" - OBI warning light

> "GENERATOR ON" - OBI warning light

Route Warning Light wiring to the Relay Junction Box.

63.294

Treatment Room safety door interlock switches are required for all installations. Provide for both 12 Vdc and 120/220 Vac door interlocks. They are normally open type switches and are used to ensure the room doors are closed during Clinac operation. Verify with the door manufacturer the type of switches supplied with the door or provide compatible type. Route interlock switches wiring to the Relay Junction Box.

VARIAN medical systems	[000] Refer to the Varian Components Chart at the end of this section.	Interconnection Wiring Diagram			
	Not For Construction	Clinac Linear Accelerators			
1.39.2 :page	planning dept.	© Varian Medical Systems 2008 All rights reserved.	17Jul09	revision: 1	doc. #: 200074 page: 1.39.2

63.493

A separate neutron door interlock switch can be accommodated in the door interlock circuit. Route interlock switch wiring to the Relay Junction Box.

63.526

A beam-off light may be controlled by the Clinac. Most sites do not use this feature. Route Warning Light wiring to the Relay Junction Box. Verify local requirements with regional regulatory agencies.

64 - Cable Access Runs**64.482**

These cables are routed to the equipment through the Relay Junction Box.

64.494

Coil 8'-0"(2440) of wire at the Modulator pull box.

65 - Pull / Junction Boxes**65.142**

The required Relay Junction Box (RJB) provides an interface with the Varian Clinac via a factory assembled and tested control panel designed to provide a convenient, organized, labor saving central connection point for the Laser positioning system, status warning lights, room lighting, door interlocks, and remote emergency off pushbuttons. The panel includes wiring diagrams to enable it to be used as a radial junction and control point simplifying the connection of the various systems. The Relay Junction Box can be located above finished ceiling (if accessible) or flush mounted to the wall, near the Clinac Modulator Cabinet. The maximum conduit length from the RJB to the Modulator cannot exceed 45'-0" (13,716). The required Relay Junction Box is available from GEXPRO (800-200-9760 X3876 or 317-554-3876) Catalog #VRJB-C3 and ordering information is available from the Planning department web page: varian.com/architectural support or contact your regional Planning Manager.

66 - Circuit Breakers / UVRs**66.040**

Provide 20A at 120 Vac or 15A at 240 Vac dedicated circuit breakers for Varian control console equipment power outlets.

66.063

An Under-Voltage Release (UVR) is required to provide the capability of disconnecting all power (except control transformer circuit) when the emergency-off circuit is broken. Otherwise, power is interrupted only by contactors in Clinac power distribution compartment. Recommend GE part #TEDUV8RS 24 Vdc. (Only if not using G.E. Main Ckt. Brkr. Panel). Uninterrupted 24 Vdc must be provided.

66.066

The Clinac Linear Accelerator or Silhouette Main Circuit Breaker Panel must be located within sight of and within 10'-0"(3050) of Clinac control equipment casework. Conspicuously identify Main Circuit Breaker as "Main Disconnect for Clinac". Select required Main Circuit Breaker from the following list:

> The Main Circuit Breaker Panel is available from GEXPRO (800-200-9760 X3876 or 317-554-3876) Catalog #2100CBB150A (Includes 150A UVR Breaker, 24Vdc Power Supply, and Push-button) and ordering information is available from the Planning department web page: varian.com/architectural support or contact your regional Planning Manager.

OR

> Line voltage - 208 Vac (typical 60 Hz): 150A UVR (24Vdc) Breaker.

> Line voltage - 400 Vac (typical 50 Hz): 80A UVR (24Vdc) Breaker.

> Fault Condition - 1000A for 0.1 second at 208 Vac or 520A for 0.1 second at 400 Vac (this is the load resulting from a fault that is interrupted by the Clinac's internal, resettable protective circuits. The Clinac Linear Accelerator produce a 1000A surge at 208 Vac or a 520A surge at 400 Vac. This surge lasts 30 to 40 milliseconds. The circuit breaker specified will accommodate this surge. The disconnect and overcurrent protection capability of the breaker is provided by its interrupt rating of 42kA at 200 to 240 Vac or 25kA at 360 to 440 Vac. Clinacs are covered under Article 517 (Health Care Facilities) of the 1993 Edition of the N.E.C. Part E deals specifically with X-Ray Installations; 517-73, which covers "Rating of Supply Conductors and Overcurrent Protection", is divided into two sub-sections: a) Diagnostic Equipment and b) Therapeutic Equipment. Clinacs are primarily therapeutic, and therefore fall under the provisions of b), which specifies simply: "The ampacity of conductors and rating of overcurrent protective devices shall not be less than 100% of the current rating of medical X-ray therapy equipment." A note associated with b), but applicable to all X-ray equipment states that the rating of the disconnecting means as well as that of the overcurrent protection and the branch-circuit conductor ampacity "are usually designated by the manufacturer for the specific installation". The provisions are consistent with recommendations made in this package.

66.171

The On-Board Imager Main Circuit Breaker Panel may be flush mounted on, or recessed in the wall. If recessed, provide a minimum 6"(150) thick wall. Locate within sight of and within 10'-0"(3050) of Clinac control equipment casework. Conspicuously identify as "Disconnect for OBI".

> Main Circuit Breaker Panel, recommended G.E. Catalog # OBI60A480V (includes 60A, 3-phase 400 - 480V circuit breaker, 60A, 480V contactor/120V coil installed in a Lockout/Tagout subpanel) or equivalent. The On-Board Imager Main Circuit Breaker Panel is available from GEXPRO (800-200-9760 X3876 or 317-554-3876) Catalog #OBI60A480V and ordering information is available from the Planning department web page: varian.com/architectural support or contact your regional Planning Manager.

69 - Power Receptacles / Switches**69.034**

Provide a dimmer switch for set-up lights. This switch is used to adjust the illumination level of the set-up lights so that they are dim enough for clear visibility of the lasers, but bright enough for safe movement through the room.

69.047

A dedicated laser positioning lights power switch is optional. The laser positioning lights are controlled through the Relay Junction Box. Route wiring to the Relay Junction Box.

69.048

A room lights switch is optional. The room lights are controlled through the Relay Junction Box. Route wiring to the Relay Junction Box.

VARIAN medical systems	[000] Refer to the Varian Components Chart at the end of this section.	Interconnection Wiring Diagram Clinac Linear Accelerators			
	Not For Construction				
1.39.3 :page	planning dept.	© Varian Medical Systems 2008 All rights reserved.	17Jul09	revision: 1	doc. #: 200074 page: 1.39.3

69.051

Provide grounded 4 plex electrical power receptacles for Varian control console equipment. Locate adjacent to the underside of the counter to provide maximum power cable extension.

69.427

Provide an electrical power receptacle at the In-Room Monitor.

69.469

Provide a power receptacle at each CCTV Camera.

69.489

A single room master switch can control the setup lights, laser positioning lights, closed circuit television system. It is often located outside the room and includes a pilot light.

69.708

The electrical loads for the Varian control console equipment are:

- > Clinac Electronics Cabinet 003 - 120VAC - 3A
- > Control Console Cabinet 030 - 120VAC - 5A
- > Control Console Cabinet 031 - 120VAC - 10A
- > Control Console Monitors (each) - 120VAC - 1A

	[000] Refer to the Varian Components Chart at the end of this section.	Interconnection Wiring Diagram Clinac Linear Accelerators			
	Not For Construction				
1.39.4	:page planning dept.	© Varian Medical Systems 2008 All rights reserved.	17Jul09	revision: 1	doc. #: 200074 page: 1.39.4

54.357 54.502

51.014 55.102

50.355 53.101 53.356 53.707 70.121

E Compressed Air Notes IDP1063

D Plumbing Notes IDP1062

C Ventilation Notes IDP1061

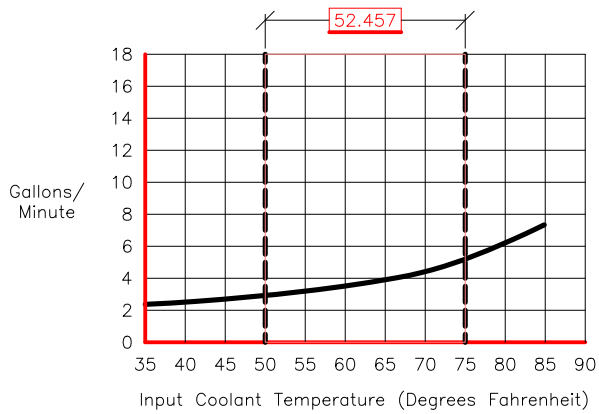

U.S. Systems - Imperial

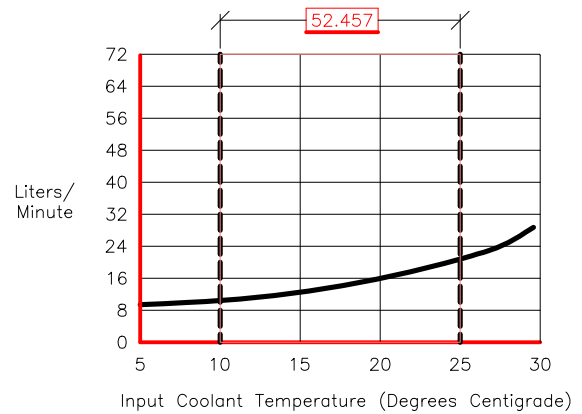

SI Systems - Metric

B Minimum Coolant Flow Requirements

IDP1060

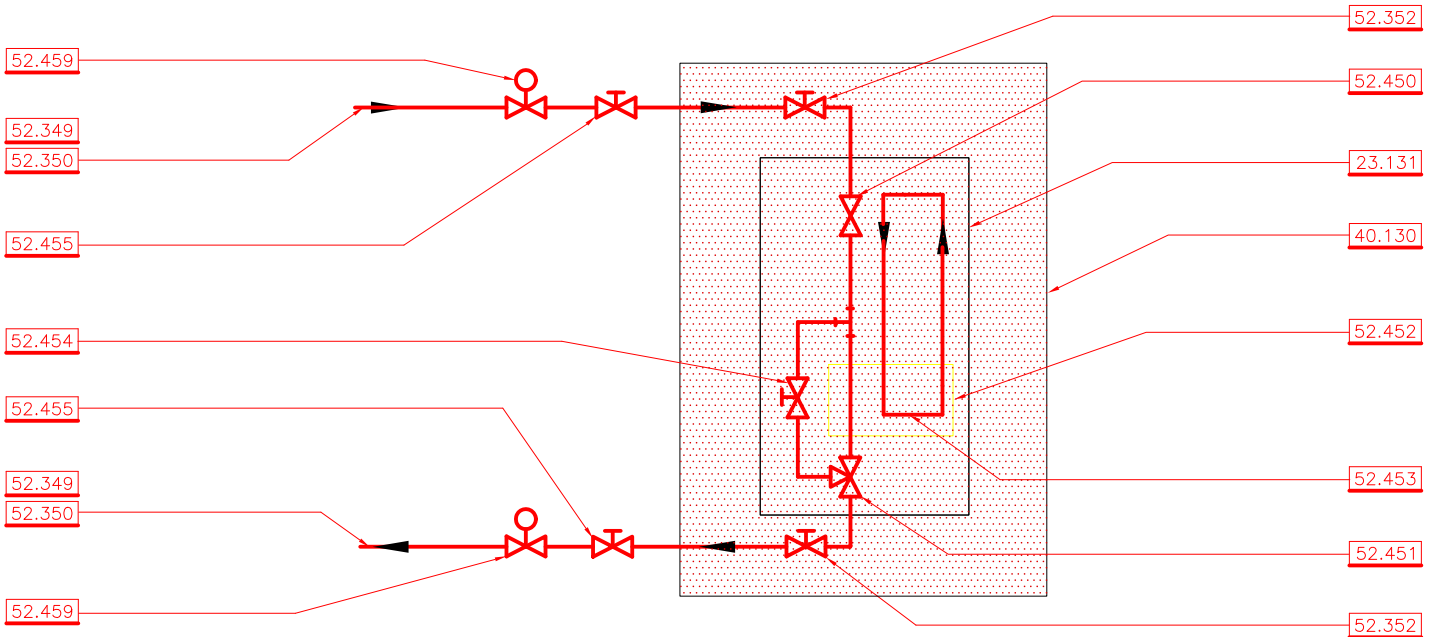

A Coolant Diagram

10.353

IDP1059

VARIAN medical systems		000 Refer to the Varian Components chart at the end of this section.	HVAC and Plumbing Requirements Clinac Linear Accelerators				
		Not For Construction					
1.40.0	:page	planning dept.	© Varian Medical Systems 2008 All rights reserved.	09Sep08	revision: 5	doc. #: 862544	page: 1.40.0

10 - General Notes

10.180

The information shown is for ALL Clinac linear accelerator models 2100C(D), 2300C/D, 21EX, 23EX, iX, Trilogy and Novalis Tx.

10.353

Use the following description of the Clinac operational states to determine the estimated utility load based on normal treatment cycles:

- > Standby - A condition usually in effect on weekends and overnight with only minimal electrical supplies operative, but with the water cooling system on.

- > Mode Release - A condition with no energy selected, all magnet and steering power supplies off, but with the klystron solenoid power supplies operative. Approximately 42 minutes per hour.
- > Ready/Energy Select - A condition with the Clinac ready to Beam-On. Approximately 6 minutes per hour.
- > Beam-On - The full-duty condition in which all primary heat sources operate at their maximum levels. Approximately 12 minutes per hour. The Beam-On State is maintained continuously for one hour or more during physics and calibration use.
- > The estimated number of minutes per hour of each state is based on an average of six patients treated per hour.

23 - Dimension Descriptions

23.131

This is the out line of the equipment Stand.

40 - Base Frame Installation / Anchorage

40.130

This is the out line of Base Frame pit recess.

50 - General Mechanical Notes

50.355

Environmental Specifications

- > Humidity range - 15% to 80% Relative Humidity, Non-condensing
- > Temperature range - 60° to 80°F (16° to 27°C)

51 - Plumbing

51.014

A sink with running hot and cold water is highly recommended in Clinac rooms. Appropriate codes should be followed regarding paddle or foot controls and type of faucet. A hose spigot is necessary to fill the water phantom and a drain is necessary to service the Clinac's internal cooling system and drain the water phantom. Floor drains and floor sinks should not be located in the room to avoid possible backup into the equipment floor recesses. Do not run water lines directly above the Clinac components or control console.

52 - Coolant System

52.349

Dual Energy Clinac Cooling Requirements:

The Dual Energy Clinac coolant heat load varies with the operational state as outlined below:

- > Standby State coolant heat load - 2 kW (6,830 Btu/hr).
- > No Mode State coolant heat load - 10 kW (34,152 Btu/hr).
- > Ready State coolant heat load - 12.5 kW (42,690 Btu/hr).
- > Beam-On State coolant heat load - 25 kW (85,379 Btu/hr).
- > Normal treatment cycles, see Clinac Operational States [10.353], will require heat dissipation into cooling water of 13.3 kW (45,422 Btu/hr).
- > Minimum operational heat load - 2 kW (6,830 Btu/hr) - 24 hour cooling required.
- > Maximum heat load (during beam-on) - 25 kW (85,379 Btu/hr).
- > Maximum overall input pressure, including normal back pressure - 100 PSIG (7 kg/cm²).
- > The pressure differential between the inlet and outlet fittings at the Clinac Stand will be adjusted to between 10 PSI (0.7 kg/cm²) and 20 PSI (1.4 kg/cm²) while the Clinac is in the Ready state.
- > The actual pressure drop through the Clinac under maximum heat load conditions is 20 PSI (1.4 kg/cm²).
- > Periodic cooling water flow through the Clinac - 0 GPM (with the internal bypass valve closed only).
- > Average water temperature rise during Beam-On, Standby, and Ready States (w/ closed bypass valve): 15 deg. C/27 deg. F.

52.350

Coolant Specification

- > The cooling water requirement can be satisfied with a one-pass system (domestic supply and waste return) or a closed-loop system. Although most water and sanitary districts restrict the use of one-pass cooling, it can generally be used for backup. If a closed-loop system is used, provide a domestic back-up system.
- > The Clinac does not contaminate the coolant.
- > Experience has shown that some local potable water supplies have caused excessive corrosion and frequent replacement of the internal Clinac heat exchanger. Under the following conditions, professional advice should be obtained to recommend appropriate water treatment:
 - When the total dissolved solids are greater than 300 mg/L and the pH (actual) is less than 6.5 or greater than 9.6.
 - When the total dissolved solids are between 100 mg/L and 300 mg/L and the pH (actual) is less than 8.2 or greater than 11.2.
 - When the total dissolved solids are less than 100 mg/L and the pH (actual) is less than 10.0 or greater than 13.0.
 - When the chloride or sulfate content is high.
- > Maximum glycol content of coolant - 50%.

52.352

Terminate cooling water supply and return lines at Base Frame pit with 1" female NPT valves and plugs. Refer to the Base Frame Pit and Installation drawing for termination location. Final connection from valves in Base Frame pit to valves in Clinac Stand will be installed by Customer/contractor using Varian provided hose kit during Clinac installation.

52.450

The pressure reducing valve located within the Clinac Stand regulates the incoming external coolant pressure.

52.451

The modulating temperature control valve is located in the Clinac Stand. This valve monitors the temperature of the returning coolant in the Clinac's internal coolant loop. It opens or closes to control the flow of external coolant through the Clinac's internal heat exchanger in order to maintain an internal coolant loop temperature of 104°F (40°C). This valve may close completely during minimum demand periods. If the bypass loop shut-off valve is open, the coolant is directed through the bypass loop.

52.452

This is the heat exchanger located in the Clinac Stand.

52.453

This is the internal Clinac coolant loop.

VARIAN medical systems	[000] Refer to the Varian Components Chart at the end of this section.	HVAC and Plumbing Requirements Clinac Linear Accelerators				
	Not For Construction					
1.40.1 :page	planning dept.	© Varian Medical Systems 2008 All rights reserved.	09Sep08	revision: 5	doc. #: 862544	page: 1.40.1

52.454

The bypass shut-off valve is located in the Clinac Stand. During installation, this valve is closed for one-pass coolant systems or opened to provide constant flow for closed-loop coolant systems. If a closed-loop system design with domestic water backup is selected, provide a means to notify the user that the Clinac bypass valve should be closed in the event that the domestic water backup system is used. This valve is present only in systems shipped after January 1994.

52.455

Provide shut-off valves on the supply and return coolant lines in an accessible location outside the Clinac vault.

52.457

The typical incoming coolant temperature range is 50°F to 75°F (10°C to 25°C). The coolant system must be designed to eliminate the possible formation of condensation. If lower temperature coolant is used, a psychrometric chart must be consulted to determine the dew point in the facility. If the inlet coolant temperature is at or below this dew point, condensation will form on the coolant system pipes which could result in equipment damage.

52.459

Provide a flow meter on the supply or return line in an accessible location near the Clinac room.

53 - Ventilation**53.101**

Ventilation - Clinacs will produce detectable levels of ozone under certain conditions. Four to six air changes per hour are normally required to maintain undetectable levels, depending on the size of the room and air circulation efficiency. Ventilation required to remove the heat dissipated to the room air normally accomplishes this. The ventilation system should use "fresh-air" as part of its design. Treatments should not be performed if the ventilation system is not in operation. Long irradiation's at high dose rates, such as those performed for physics measurements, should be followed by "airing out" the room. It is important to provide positive air pressure in the Clinac room to "hold" swing-type doors closed.

53.356

Provide ventilation sufficient for removal of equipment air heat load as follows:

Clinac Vault

> 5.0 kW (17,060 Btu/hr) at Clinac Stand/Gantry during Ready and Beam-On states.

> 1.5 kW (5,123 Btu/hr) at Clinac Stand/Gantry during No Mode state.

> 1.0 kW (3,415 Btu/hr) at Clinac Stand/Gantry during Standby state.

> 3.0 kW (10,246 Btu/hr) at Modulator Cabinet during Beam-On.

> 0.5 kW (1,707 Btu/hr) at Modulator Cabinet during other states.

53.707

Provide ventilation sufficient for removal of control console air heat load as follows:

> Clinac Electronics Cabinet 003 > 1.0 kW (3,415 Btu/hr)

> Control Console Cabinet 030 > 1.5 kW (5,123 Btu/hr)

> Control Console Cabinet 031 > 2.3 kW (7,855 Btu/hr)

> ARIA Option Workstation > 0.5 kW (1,707 Btu/hr)

54 - Compressed Air System**54.357**

Terminate 1/2" compressed air line at the Base Frame pit with 1/2" female NPT ball valve. Refer to the Base Frame Pit and Installation drawing for termination location. Final connection from valve in Base Frame pit to valve in Clinac Stand will be installed by Customer/contractor using Varian provided hose kit during Clinac installation.

54.502

Compressed air is required for the Clinac and Silhouette Linear Accelerators. Provide instrument quality, dry compressed air per ISA-7.0.01-1996, with a maximum particle size of 5µm. If an existing system is not available, provide a dedicated system. Provide a minimum of 1cfm at 50 psig (1.7 m³/hour at 3.6 kg/cm²). A 10 gallon (38 liter) tank capacity is adequate.

55 - Fire Protection**55.102**

Sprinklers inside the treatment room are discouraged. Their discharge or inadvertent leakage into the Couch pit or into the Stand generate expensive repairs with extended shut-downs. Some jurisdictions allow substitution of Type I construction for fire protection. Detectors are strongly recommended and normally adequate if a type "C" fire extinguisher is available in the treatment room. Heat detectors or photo-electric smoke detectors are preferred because ionization-type detectors can, under certain circumstances, give false alarms. If fire sprinklers are required by local authorities, sprinkler heads should not be located above the equipment. A system valved and controlled by the smoke detector (dry pre-action) can be incorporated so that sprinklers are "wet" only upon specific need. Semi- or fully recessed, high temperature heads are recommended in "wet" systems. The safety of non-ambulatory patients should be reviewed if a chemical system is considered. Verify all regional regulatory code requirements.

70 - Radiation Shielding**70.121**

To reduce radiation exposure outside room, air handling ducts should enter/exit the room through penetration(s) above the maze door. The ducts should be placed as high as possible in order to minimize radiation exposure to occupied space. The ducts should be designed to minimize the area of penetration through the wall. In most cases, duct shielding will not be required, provided the duct design conforms to this criteria. Clear space should be left around the duct (outside the treatment room) for shielding retrofit, in case the post installation radiation survey indicates a requirement. Penetration, including ducts, directly into the treatment room should be avoided. For no-maze treatment rooms, duct design and shielding must be addressed by the Physicist of Record.

	[000] Refer to the Varian Components Chart at the end of this section.	HVAC and Plumbing Requirements Clinac Linear Accelerators			
	Not For Construction				
1.40.2 :page	planning dept.	© Varian Medical Systems 2008 All rights reserved.	09Sep08	revision: 5	doc. #: 862544 page: 1.40.2

The following component information is designed to be used in conjunction with the IDP section listed below. The dimensions and weights listed are subject to change. The weights and dimensions listed represent the installed condition. The decibel levels listed represent the maximum dB in the workplace under normal conditions as measured on response curve "A". Several component sets (i.e. ARIA, MLC_PV) may be sold as Customer options with the Clinac and Acuity or may be sold separately. With the exception of the VM/IRM components, ARIA component models vary and the dimensions given are typical only. Verify the actual equipment ordered with the Customer or the Varian District Sales Manager. "n/a" means either "not applicable" or "not available".

Varian Clinac Linear Accelerators Components

Key	Equipment	Height	Width	Depth	Weight	Max Watts	Max dbA	Reference Keynotes
		inch (mm)	inch (mm)	inch (mm)	lb (kg)			
003	Clinac Electronics Cabinet	31 (787)	24.5 (622)	32.5 (826)	240 (109)	1200	57	21.077
004	Log Printer	5 (127)	17 (432)	8 (203)	12 (5)	50	n/a	31.223
005	In-Room Monitor	13.5 (343)	17.5 (445)	4 (102)	15.5 (7)	n/a	n/a	21.012, 41.011
007	Clinac Dual Energy Stand/Gantry Assembly	104 (2642)	49 (1245)	149 (3785)	13765 (6243)	5000	76	21.096, 21.198
008	Exact Treatment Couch	67 (1702)	24 (610)	85 (2159)	1357 (615)	n/a	72	21.088, 21.117, 21.118, 21.180, 21.197
009	Modulator Cabinet	66 (1676)	48 (1219)	31 (787)	1800 (816)	3000	74	21.209
019	Dual Energy Clinac VEO Base Frame	11 (279)	58 (1473)	141 (3581)	2100 (952)	n/a	n/a	
020	Workstation Mouse	1.5 (38)	3.5 (89)	5.5 (140)	0.25 (0)	n/a	n/a	
021	Workstation Keyboard	2 (51)	19 (483)	8 (203)	4 (2)	n/a	n/a	
022	Workstation Computer	22 (559)	9 (229)	26 (660)	27 (12)	240	n/a	
023	Workstation Monitor	13.5 (343)	17.5 (445)	4 (102)	15.5 (7)	n/a	n/a	
024	Workstation Printer	7 (178)	15 (381)	14 (356)	16 (7)	380	n/a	
025	Un-Interruptable Power Supply	11 (279)	5.2 (132)	17 (432)	45 (20)	n/a	n/a	
028	Server Computer	26 (660)	18 (457)	26 (660)	50 (23)	240	n/a	21.278
029	Monitor T-Switch	2.5 (64)	8 (203)	6 (152)	4 (2)	n/a	n/a	65.078
030	Clinac Console Cabinet	33.5 (851)	22.5 (572)	35.5 (902)	215 (98)	1200	20	
031	Clinac Console Cabinet	33.5 (851)	45.5 (1156)	35.5 (902)	560 (254)	2400	20	
044	MLC Digitizer	2.5 (64)	26 (660)	7 (178)	9.5 (4)	12	n/a	
047	MLC Controller	13.5 (343)	16 (406)	16 (406)	35 (16)	550	n/a	
049	MLC Line Conditioner	8 (203)	8.5 (216)	13.5 (343)	35 (16)	27	n/a	
050	PV Video Imager	10.5 (267)	16.5 (419)	21 (533)	40 (18)	100	n/a	
055	PV Optical Disk Drive	5 (127)	9 (229)	13 (330)	15 (7)	150	n/a	
056	PV Image Interface	6 (152)	18.5 (470)	18.5 (470)	45 (20)	345	n/a	
057	PV Film Digitizer	29 (737)	25.5 (648)	24 (610)	41 (19)	75	n/a	

VARIAN medical systems	[XX.XXX] See the referenced keynotes on the appropriate drawings.	Varian Component Table Clinac Linear Accelerators			
	Not For Construction				
1.41.1 :page	planning dept.	© Varian Medical Systems 2008 All rights reserved.	20Jul09	revision: 6	doc. #: 1100740 page: 1.41.1

Varian Clinac Linear Accelerators Components

Key	Equipment	Height	Width	Depth	Weight	Max Watts	Max dbA	Reference Keynotes
		inch	inch	inch	lb			
		(mm)	(mm)	(mm)	(kg)			
058	PV Thermal Video Printer	5 (127)	16 (406)	15 (381)	24.5 (11)	n/a	n/a	
080	Control Foot Switch	5 (127)	6 (152)	6 (152)	6.1 (3)	n/a	n/a	
083	OBI/Trilogy-H.F. Generator	50.8 (1290)	19.7 (500)	18.2 (462)	250 (113)	n/a	n/a	
088	PaxScan Image Command Processor	5.5 (140)	11 (279)	12.5 (318)	16 (7)	n/a	n/a	
170	4D-Integrated Treatment Console	5 (127)	24 (610)	9 (229)	5 (2)	n/a	n/a	
171	Varian Computer Cabinet #1	36 (914)	32 (813)	32 (813)	400 (181)	n/a	n/a	
172	Varian Computer Cabinet #2	36 (914)	32 (813)	32 (813)	400 (181)	n/a	n/a	
173	4DITC Monitor Bracket	n/a	n/a	n/a	n/a	n/a	n/a	Varian Installed
174	KVM Switch for 4DITC	5 (127)	2.5 (64)	4 (102)	1 (0)	n/a	n/a	
175	4DITC LCD Treatment Console Monitors.	20 (508)	22 (559)	4 (102)	18 (8)	n/a	25	

	[XX.XXX] See the referenced keynotes on the appropriate drawings.	Varian Component Table Clinac Linear Accelerators			
	Not For Construction				
1.41.2 :page	planning dept.	© Varian Medical Systems 2008 All rights reserved.	20Jul09	revision: 6	doc. #: 1100740 page: 1.41.2

Clinac Pre-Installation Checklist

In accordance with current Varian "Standard Terms and Conditions of Sale" RAD 1652, para. 15 & 16, the following are the minimum facility requirements to be accomplished before the shipment of your Clinac can begin. Request for any exceptions should be referred to your Varian Regional Installation Project Manager. The Customer is responsible for having the building, utilities, lighting, ventilation, air conditioning, mounting facilities, all necessary radiation shielding, and access to the room completed by the day of final inspection. (If delays in completion delay installation, the Customer shall reimburse Varian at Varian's standard service rates for any extra time and /or travel by Varian made necessary by the delay). I have explained these requirements to the Customer on this date along with the specific requirements listed below.

Varian Representative	Date	Customer Representative	Date
Site		Equipment Type	Serial Number
<p>Y N ARCHITECTURAL REQUIREMENTS:</p> <p><input type="checkbox"/> <input type="checkbox"/> 1. Drawings reviewed by the Planning Department and a copy of drawing review on file.</p> <p><input type="checkbox"/> <input type="checkbox"/> 2. Copy of Accelerator/ Radiation License.</p> <p>Y N CLINAC TREATMENT ROOM:</p> <p><input type="checkbox"/> <input type="checkbox"/> 3. Treatment room door and related hardware on hand. Door should be hung only if it does not interfere with machine rigging.</p> <p><input type="checkbox"/> <input type="checkbox"/> 4. Verify a clear 4'-0" x 7'-0" (1225mm x 2125mm) opening room.</p> <p><input type="checkbox"/> <input type="checkbox"/> 5. Base frame - set and grouted in place.</p> <p><input type="checkbox"/> <input type="checkbox"/> 6. Conduits - correct number and size (conduits must be clean and dry).</p> <p><input type="checkbox"/> <input type="checkbox"/> 7. Varian Interconnect cables on site.</p> <p><input type="checkbox"/> <input type="checkbox"/> 8. Relay junction box - installed, wired and wiring run to: -Modulator cabinet (2100C/D, 2300C/D, 21EX, 23EX, iX, Silhouette, Trilogy or Novalis Tx) -Base frame (Clinac 600C).</p> <p><input type="checkbox"/> <input type="checkbox"/> 9. Main room lights and set-up lights operational.</p> <p><input type="checkbox"/> <input type="checkbox"/> 10. Door interlock wiring pulled and switches operational (high and low voltage).</p> <p><input type="checkbox"/> <input type="checkbox"/> 11. Emergency - off buttons installed and wiring pulled.</p> <p><input type="checkbox"/> <input type="checkbox"/> 12. Warning light installed and wiring pulled. (Incandescent lamp only)</p> <p><input type="checkbox"/> <input type="checkbox"/> 13. Laser light wiring, receptacles, and mounting plates installed. Verify location, heights and recess size.</p> <p><input type="checkbox"/> <input type="checkbox"/> 14. In - room monitor (if ordered) – verify location, mounting, power and data cable conduit.</p> <p><input type="checkbox"/> <input type="checkbox"/> 15. Water coolant - in pit and valved below floor level with supply tested and available.</p> <p><input type="checkbox"/> <input type="checkbox"/> 16. HVAC operational (meets Varian minimum requirements).</p> <p><input type="checkbox"/> <input type="checkbox"/> 17. Compressed air in pit. (Instrument quality) (2100C/D, 2300C/D, 21EX, 23EX, iX, Silhouette, Trilogy or Novalis Tx only)</p> <p><input type="checkbox"/> <input type="checkbox"/> 18. Plumber and Electrician available to connect utilities to machine no later than two days after Clinac rigging is complete.</p> <p><input type="checkbox"/> <input type="checkbox"/> 19. Walls finished (Primer coat minimum).</p> <p><input type="checkbox"/> <input type="checkbox"/> 20. Ceiling completed - verify height (Check for soffit clearances and laser obstructions).</p> <p><input type="checkbox"/> <input type="checkbox"/> 21. Cabinetwork, shelving, and storage completed and installed in treatment room. (If not in Rig Path)</p>		<p><input type="checkbox"/> <input type="checkbox"/> 22. Floor covering installation is recommended one week after the Clinac has been rigged onto its base frame.</p> <p><input type="checkbox"/> <input type="checkbox"/> 23. Riggers contracted to move the Clinac into the room, set in place and assist in assembling of major components.</p> <p><input type="checkbox"/> <input type="checkbox"/> 24. Rig path - verify clearances from unloading area to vault.</p> <p>Y N CONTROL EQUIPMENT AREA:</p> <p><input type="checkbox"/> <input type="checkbox"/> 25. Power - all wiring pulled to main breaker(s) and into vault.</p> <p><input type="checkbox"/> <input type="checkbox"/> 26. Main GE breaker panel – High Energy Model - 2100CBB150A Low Energy Model - 600CBB70A, Trilogy\OBI –OBI60A480V</p> <p><input type="checkbox"/> <input type="checkbox"/> 27. If not GE breaker panel – Equivalent with 24VDC P/S.</p> <p><input type="checkbox"/> <input type="checkbox"/> 28. ARIA Network Pre-Installation Checklist completed (If ARIA network option components are being installed).</p> <p><input type="checkbox"/> <input type="checkbox"/> 29. Walls finished (Primer coat minimum).</p> <p><input type="checkbox"/> <input type="checkbox"/> 30. Floor covering installed if not in the Clinac rigging path.</p> <p><input type="checkbox"/> <input type="checkbox"/> 31. Ceiling completed - lighting installed.</p> <p><input type="checkbox"/> <input type="checkbox"/> 32. Dedicated modem line provided (if Remote Diagnostics is being installed).</p> <p><input type="checkbox"/> <input type="checkbox"/> 33. Cabinetwork shelving completed for console.</p> <p><input type="checkbox"/> <input type="checkbox"/> 34. Verify electronics cabinet opening (for adequate cooling).</p> <p><input type="checkbox"/> <input type="checkbox"/> 35. Telephone – Operational at console area</p>	
		<p>Y N OTHER:</p> <p><input type="checkbox"/> <input type="checkbox"/> 35. Inform Applications of Installation Rig Dates.</p> <p><input type="checkbox"/> <input type="checkbox"/> 36. Operational film processor available for use in Clinac area.</p> <p><input type="checkbox"/> <input type="checkbox"/> 37. Provisions made for approximately 150 sq.ft. of secure storage.</p> <p><input type="checkbox"/> <input type="checkbox"/> 38. Provisions made for removal of shipping crates, boxes and packing material. (Customer Responsibility)</p> <p><input type="checkbox"/> <input type="checkbox"/> 39. Area sealed to ensure that construction dust particles from adjoining areas do not enter treatment room or console area.</p> <p><input type="checkbox"/> <input type="checkbox"/> 40. Qualified physicist scheduled for preliminary radiation survey: Clinac 600C: approximately 5 days after start of installation. Clinac 2100C/D, 2300C/D, 21EX, 23EX, iX, Silhouette, Trilogy or Novalis Tx: Approximately 7 days after the start of installation.</p> <p><input type="checkbox"/> <input type="checkbox"/> 41. Qualified physicist and dosimeter calibration equipment available for acceptance testing: Clinac 600C: approximately 3 weeks after start of installation. Clinac 2100C/D, 2300C/D, 21EX, 23EX, iX, Silhouette, Trilogy or Novalis Tx: Approximately 4 weeks after start of installation.</p>	

NOTES:

The dimensions and weights listed are approximate and subject to change. The weights and dimensions listed represent the as shipped condition. Verify the actual equipment ordered with the Customer or the Varian District Sales Manager. The designation "n/a" means either "not applicable" or "not available".

Varian Clinac Linear Accelerators Shipping List

Item	Description	Length		Width		Depth		Weight	
		inch	(mm)	inch	(mm)	inch	(mm)	lb	(kg)

A. Standard 3 Piece Breakdown Clinac All HE Models

01.	Drive Stand/Gantry	145	(3683)	45	(1143)	76	(1930)	13765	(6243)
02A.	Counterweight	36	(914)	36	(914)	47	(1194)	5660	(2567)
02B.	Beamstopper (Optional - 6700 lbs/3039 kg)	78	(1981)	40	(1016)	48	(1219)		
03.	Electronic rack	56	(1422)	54	(1372)	47	(1194)	1070	(485)

Total: 20495 9295

B. Optional 4 Piece Breakdown Clinac All HE Models

01.	Drive stand	48	(1219)	45	(1143)	76	(1930)	3785	(1717)
02.	Gantry	105	(2667)	45	(1143)	76	(1930)	9980	(4526)
03A.	Counterweight	36	(914)	36	(914)	47	(1194)	5660	(2567)
03B.	Beamstopper (Optional - 6700 lbs/3039 kg)	78	(1981)	40	(1016)	48	(1219)		
04.	Electronic rack	56	(1422)	54	(1372)	47	(1194)	1070	(485)

Total: 20495 9295

C. Remaining Items, Clinac All HE Models

01.	Modulator	56	(1422)	39	(991)	83	(2108)	1830	(830)
02.	Console	46	(1168)	37	(940)	45	(1143)	415	(188)
03.	Klystron	50	(1270)	30	(762)	21	(533)	205	(93)
04.	Elevator (Exact)	63	(1600)	32	(813)	47	(1194)	1485	(673)
05.	Stretcher (Exact)	91	(2311)	29	(737)	15	(381)	280	(127)
06.	Stand covers (small)	99	(2515)	21	(533)	27	(686)	300	(136)
07.	Stand covers (large)	101	(2565)	51	(1295)	19	(483)	530	(240)
08.	Aux. Electronics	29	(737)	26	(660)	20	(508)	135	(61)
09.	RF driver	26	(660)	26	(660)	15	(381)	75	(34)
10.	Misc. # 1	48	(1219)	31	(787)	39	(991)	400	(181)
11.	Misc. # 2	48	(1219)	31	(787)	39	(991)	400	(181)
12.	Misc. # 3	48	(1219)	31	(787)	39	(991)	400	(181)
13.	Oil drum	23	(584)	23	(584)	35	(889)	450	(204)
14.	Modulator doors	81	(2057)	19	(483)	38	(965)	300	(136)
15.	Aux. Electronics	29	(737)	26	(660)	20	(508)	135	(61)
16.	SF6 gas # 1	7	(178)	7	(178)	27	(686)	46	(21)
17.	SF6 gas # 2	7	(178)	7	(178)	27	(686)	46	(21)
18.	Paint	18	(457)	12	(305)	12	(305)	5	(2)
19.	Couch Elevator	62	(1575)	30	(762)	36	(914)	1490	(676)
20.	Couch Stretcher	290	(7366)	91	(2311)	15	(381)	280	(127)
21.	Base Frame - VEO Style	146	(3708)	62	(1575)	25	(635)	2910	(1320)
22.	Clinac Console Cabinet 030	46	(1168)	33	(838)	44	(1118)	441	(200)
23.	Clinac Console Cabinet 031	46	(1168)	43	(1092)	56	(1422)	793	(360)
24.	Integrated OBI Arm Assembly	88	(2235)	33	(838)	48	(1219)	1543	(700)

Total: 14894 6755

D. Fiberglass Gantry Panels, Clinac All HE Models

01.	Rear and Center Cover	68	(1727)	59	(1499)	46	(1168)	285	(129)
02.	Upper and Lower Cover	82	(2083)	45	(1143)	28	(711)	170	(77)
03A.	Counterweight cover	52	(1321)	33	(838)	27	(686)	96	(44)
03B.	Beam Stopper cover rear	52	(1321)	36	(914)	36	(914)	110	(50)
03C.	Beam Stopper cover upper	60	(1524)	36	(914)	12	(305)	55	(25)
03D.	Beam Stopper cover lower	60	(1524)	36	(914)	12	(305)	55	(25)

Total: 771 350

	[XX.XXX] See the referenced keynotes on the appropriate drawings.	Shipping List			
	Not For Construction	Clinac Linear Accelerators			
1.43.1 :page	planning dept.	© Varian Medical Sytems 2008 All rights reserved.	25Feb09	revision: 4	doc. #: 1102394 page: 1.43.1

Page Index
Clinac Linear Accelerators

<p style="text-align: center;">A</p> <p>Accessories</p> <p>1</p> <p>1.0</p> <p>1.22</p> <p>1.23</p> <p>1.27</p> <p>1.30</p> <p>1.31</p> <p>Acoustics</p> <p>1.23</p> <p>ARIA</p> <p>1</p> <p>1.27</p> <p>1.28</p> <p>1.33</p> <p>1.39</p> <p style="text-align: center;">B</p> <p>Base Frame</p> <p>1.22</p> <p>1.23</p> <p>1.26</p> <p>1.35</p> <p>1.36</p> <p>1.40</p> <p>Beam-on light</p> <p>1.39</p> <p>Beamstopper</p> <p>1.23</p> <p>1.25</p> <p>1.26</p> <p style="text-align: center;">C</p> <p>Cable access</p> <p>1.0</p> <p>1.22</p> <p>1.23</p> <p>1.33</p> <p>1.34</p> <p>1.35</p> <p>1.36</p> <p>1.37</p>	<p>1.38</p> <p>1.39</p> <p>CCTV system</p> <p>1.22</p> <p>1.27</p> <p>1.32</p> <p>1.38</p> <p>Circuit Breaker Panel</p> <p>1.0</p> <p>1.27</p> <p>1.37</p> <p>1.38</p> <p>1.39</p> <p>Clearance - back wall</p> <p>1.23</p> <p>1.25</p> <p>1.33</p> <p>1.34</p> <p>1.35</p> <p>Clearance - ceiling</p> <p>1.22</p> <p>1.23</p> <p>1.26</p> <p>1.29</p> <p>1.33</p> <p>1.37</p> <p>Clearance - couch</p> <p>1.23</p> <p>1.25</p> <p>1.35</p> <p>Clearance - door</p> <p>1.23</p> <p>1.24</p> <p>Clinac Electronics Cab.</p> <p>1.27</p> <p>Compressed air</p> <p>1.35</p> <p>1.36</p> <p>1.40</p> <p>Connections - electrical</p> <p>1.0</p> <p>1.37</p>	<p>Control equipment</p> <p>1</p> <p>1.0</p> <p>1.22</p> <p>1.23</p> <p>1.27</p> <p>1.28</p> <p>1.39</p> <p>Coolant system</p> <p>1.35</p> <p>1.36</p> <p>1.40</p> <p style="text-align: center;">D</p> <p>Door interlocks</p> <p>1.38</p> <p>1.39</p> <p>Door operator switch</p> <p>1.22</p> <p>1.38</p> <p style="text-align: center;">E</p> <p>Electrical power</p> <p>1.0</p> <p>1.27</p> <p>1.28</p> <p>1.32</p> <p>1.37</p> <p>1.38</p> <p>1.39</p> <p>Emergency-off switches</p> <p>1.22</p> <p>1.38</p> <p>1.39</p> <p>ETR Couch</p> <p>1.35</p> <p>Exact Treatment Couch</p> <p>1.23</p> <p>1.25</p> <p>Experiment Access Conduit</p> <p>1.37</p> <p>1.38</p>	<p style="text-align: center;">F</p> <p>Fire protection</p> <p>1.40</p> <p>Flooring</p> <p>1.22</p> <p>1.27</p> <p>1.35</p> <p style="text-align: center;">G</p> <p>Grout</p> <p>1.35</p> <p>1.36</p> <p style="text-align: center;">H</p> <p>HF Generator Cabinet</p> <p>1.0</p> <p>Humidity</p> <p>1.40</p> <p>HVAC - duct penetration</p> <p>1.21</p> <p>1.22</p> <p>1.23</p> <p>1.40</p> <p>HVAC - ventilation</p> <p>1.0</p> <p>1.27</p> <p>1.34</p> <p>1.40</p> <p style="text-align: center;">I</p> <p>In-Room Monitor</p> <p>1.23</p> <p>1.27</p> <p>1.33</p> <p>1.37</p> <p>1.38</p> <p>1.39</p> <p>Intercom system</p> <p>1.22</p> <p>1.27</p> <p>1.38</p> <p>Isocenter</p>
--	--	--	---

Page Index
Clinac Linear Accelerators

1.22	1.39	Relay junction box	Temperature - room
1.23	O	1.0	1.40
1.25	Operational states	1.37	Total body irradiation
1.26	1.39	1.38	1.23
1.29	1.40	1.39	U
1.35	P	Rigging	Under Voltage Release
L	Phone lines	1.23	1.39
Laser positioning lights	1.27	1.24	V
1.21	1.38	Room lighting	VariSource
1.22	Physics conduit	1.22	1
1.23	1.37	1.38	1.21
1.29	1.38	1.39	1.22
1.38	PortalVision	S	1.32
1.39	1.28	Seismic anchorage	1.38
M	1.39	1.23	1.40
Magnetic shielding	Pull box - Base Frame	1.33	W
1.21	1.35	1.34	Warning lights
Maze	1.36	1.35	1.0
1.21	1.37	1.36	1.22
1.22	Pull box - Control Equip.	Separation wall	1.37
Modulator Cabinet	1.27	1.23	1.38
1.25	1.37	Sink	1.39
1.34	Pull box - Modulator	1.22	
1.39	1.34	1.23	
Monitor T-Switch	1.37	1.30	
1.27	R	1.40	
Multileaf Collimator	Radiation Detector	Skylights / Atria	
1	1.38	1.38	
1.27	Radiation Monitor	1.39	
1.28	1.38	Static electricity	
1.39	Radiation shielding	1.22	
N	1.21	1.27	
Network	1.22	1.35	
1.22	1.22	Storage - installation	
1.27	1.23	1.24	
1.28	1.25	Storage - room	
1.37	1.26	1.22	
1.38	1.29	1.23	
Neutron doors	1.40	1.30	
1.21	Ready light	1.31	
1.23	1.39	T	

Respiratory Gating Section Notes

Information and Support

This section describes only information on specific equipment facility requirements for Varian *Respiratory Gating system*. For more information, contact your nearest regional support office or Varian's main Planning Department at:

Varian Medical Systems
Planning Department
911 Hansen Way, Building 3 M/S C-165
Palo Alto, CA 94304-1028
(800) 278-2747
(650) 424-5945
(650) 424-6252 Fax
<http://www.varian.com> -architectural support

Varian/Customer Sales Contract specifies:

- Services supplied by Varian
- Computer hardware supplied by Varian
- Application Software version to be supplied by Varian
- Respiratory Gating interface to Clinac, Acuity or CT Scanner (as applicable)
- Special Terms or condition of sale
- Estimated ship date
- Shipping address

Equipment Information

To simplify the design process, we suggest that the Architect and Customer determine, as early as possible, all equipment configurations ordered or planned for the future. Below is a summary of the most common configurations:

Respiratory Gating System may be connected to (please list all the machines in your department):

Clinac 2100C/D, 2300C/D S/N.....()
Clinac 21/23 EX S/N.....()
Clinac 600C/D, 6EX S/N()
iX, Trilogy S/N.....()
Novalis Tx.....()
Acuity()
CT Simulator()
Other Simulator()

The Respiratory Gating (Real-Time Position Management) system monitors and corrects for tumor/lesion movement with respiration during radiation therapy. The Respiratory Gating system employs a video camera and real-time digital image processing to monitor the movement of a passive, infrared-reflective marker placed on the patient's chest or abdomen. Respiratory gating techniques require the use of one gating system for treatment simulation and a second gating system for Clinac treatment delivery. Simulator configuration information (fluoroscopy or CT, vendor, model, etc.) must be provided to Varian in advance of product shipment and installation.

Typical Duties of the Parties

To help assure a trouble-free project, good communications between the Customer, Architect and Contractor, and a clear agreement with the assignment of responsibilities involved in the construction or remodeling of the *Clinac, Simulator or CT Simulator* room, we suggest inclusion of the following material in the appropriate sections of the

Architectural Specification. Refer to the Customer/Varian *Terms and Conditions of Sale* and the Customer Purchase Order for a complete description of project-specific responsibilities.

The Customer shall:

- Provide supervision and temporary services/facilities.
- Provide As-Built Documentation (existing facility).
- Provide seismic testing for all supportive anchoring.
- Provide Respiratory Gating Project Manager
- Assign an internal representative for acceptance verification with Varian Installer
- Schedule initial training for staff with Varian applications manager
- Verify the Varian Pre-Installation Checklist is completed.
- Provide equipment and material storage during construction.
- Provide Punch-List resolution and Warranty follow-up.

The Architect shall:

- Provide complete Architectural & Engineering Construction Documents for review.
- Provide Construction Regulatory Agency approval.
- Monitor conformance of the construction to the Construction Documents.
- Provide As-built documentation. (existing Facility)

The Contractor shall:

- Provide structural alterations as required.
- Provide casework, cabinetry, doors or other millwork.
- Provide electrical systems as required for room occupancy, including lighting and power distribution.
- Provide and connect electrical utilities required for the *Gating* system.
- Provide periodic and final cleanup.
- Remove Varian shipping crates.
- Pull Varian interconnect cables.
- Provide and pull network cables, where required.
- Maintain treatment room and control equipment area in a dust free and vandal-proof condition during *Gating System* assembly and testing.

Varian shall:

- Provide *Respiratory Gating* equipment.
- Provide planning assistance.
- Provide Construction Document review.
- Provide Installation and testing.
- Provide Customer Training.

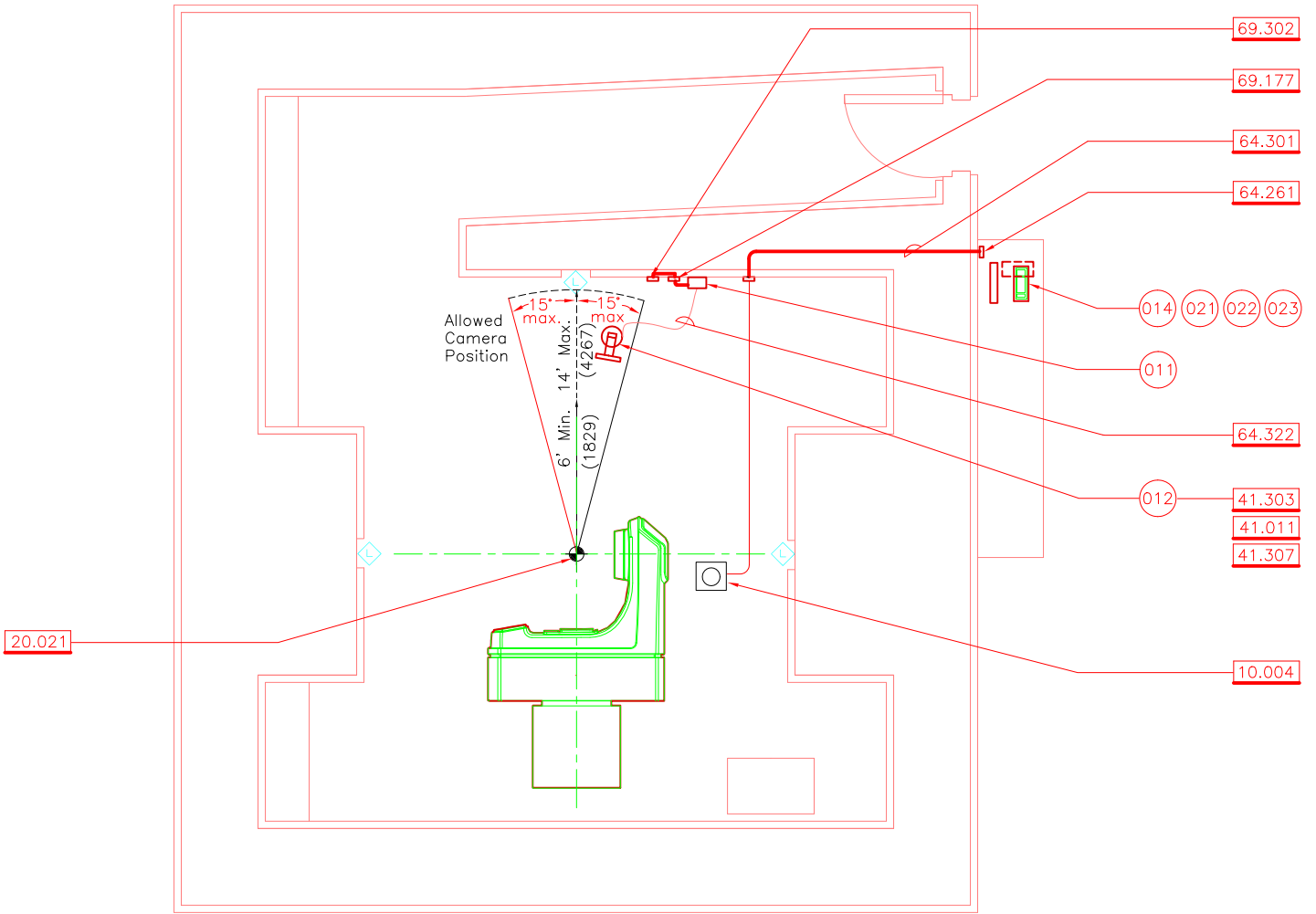

B Respiratory Gating Installation - Typical Clinac Room Plan View 10.124 NOT TO SCALE IDP200002

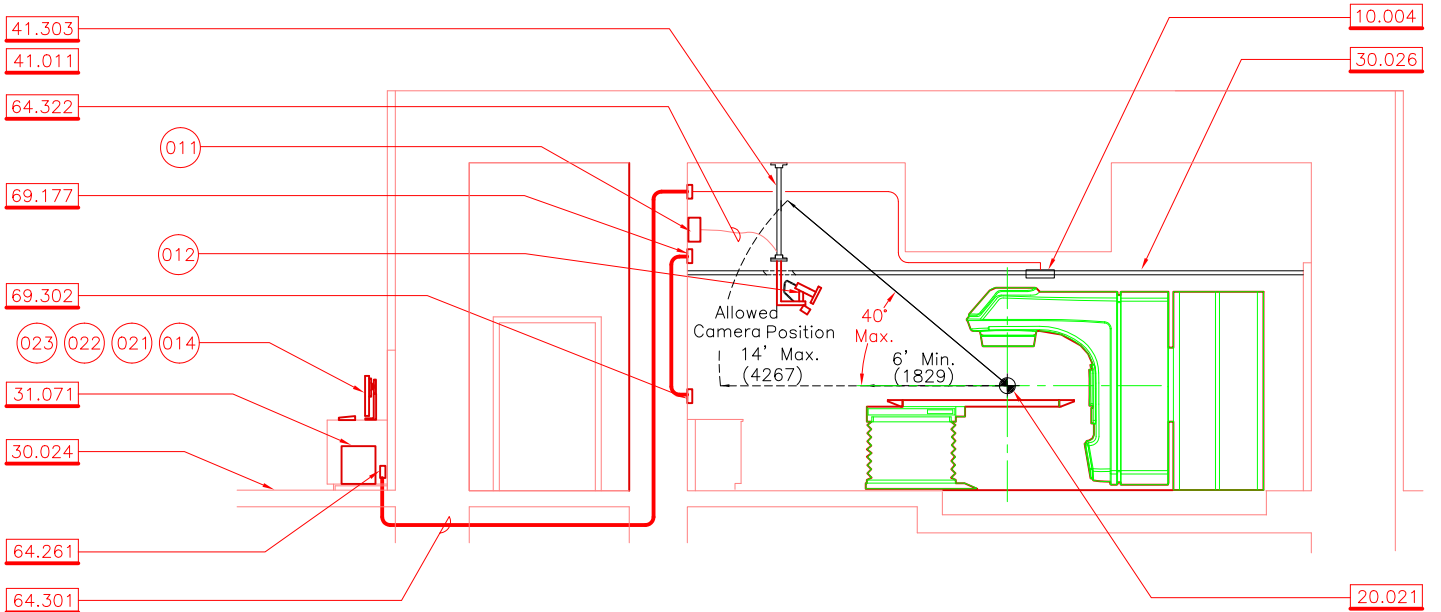

A Respiratory Gating Installation - Typical Clinac Room Section 10.124 NOT TO SCALE IDP200001

	Refer to the Varian Components table.	Respiratory Gating Installation Typical Clinac Treatment Room				
	Not For Construction					
G.1.0 :page	planning dept.	© Varian Medical Systems 2004 All rights reserved.	24Jan08	revision: 3	doc. #: 200001	page: G.1.0

10 - General Notes

10.004

Audio prompts are available on the output jack of the Gating Workstation (1/8" audio connector, 1 vrms full scale output voltage). The customer shall provide all wiring, amplification and speakers required to provide audio to the patient. The speaker wiring can be run to the treatment room pull box, to the control console pull box. The speaker should be mounted in close proximity to the treatment couch. (wall or ceiling mount)

10.124

The layouts shown on IDP drawings represent typical treatment room plans. Clearances and wall thicknesses vary.

20 - General Layout Notes

20.021

Isocenter - This is the primary reference point for Varian equipment. Show the isocenter location clearly on all relevant drawings. Maintain the isocenter location on site by extending perpendicular axis lines along slab and up walls in all four directions. The isocenter heights for Varian systems fall within 4'-2" to 4'-4.5". (1267 to 1330) The installed Gating Camera location shall be the same location in the Simulator and Clinac treatment rooms.

If using gating with a Non-Varian machine, verify isocenter with specific vendor.

30 - Finishes

30.024

As with most computer components, the electronic components for this equipment are sensitive to localized static electricity. Carpeting or other flooring adjacent to the equipment in the room or at the control equipment area should not exceed a 2.0 kV rating at 20% relative humidity when measured as outlined by the methods in AATCC-134. Retrofit static dissipative coatings are also available from various manufacturers. Carpet, while otherwise advantageous, can make gurney movement difficult. Floor stains are common due to the use of dyes to mark reference points on patients. Many facilities use carpet squares that can be replaced or cleaned and allow access to floor duct if used.

30.026

Exposed grid ceilings allow for access to the power supply without the use of access doors. Service at the equipment is simplified where there are removable ceiling tiles. Coordinate the layout of ceiling tile to insure that ceiling support system does not interfere with the camera support and bracket.

31 - Control Equipment Casework

31.071

Provide a minimum 3"(75) air and cable space at sides, top and rear of all computers and monitors.

41 - Component Anchorage Brackets

41.011

If equipment is to be anchored to a wall or ceiling, provide appropriate structural backing. Camera mounting bracket (by Varian), bracket support (by Customer). Install per bracket manufacturer's instructions. Verify mounting height with local codes and other requirements described in the IDP for this product.

41.303

The Gating Camera can be mounted either from the ceiling or on the wall per the customers preference. The Installation Data Package (doc. #: 200007) contains mounting details for either option.

41.307

The Camera position in the Clinac treatment room should be as close as possible to the location of the camera in the Simulator room, to plus or minus 12". For use with CT simulators the camera in the Clinac room should be as close as possible to the center line of the couch.

64 - Cable Access Runs

64.261

Except as noted, all conduits, pull boxes and junction boxes shall be supplied, sized and located by the Customer.

64.301

Provide 1" (25) cable conduit with a standard computer signal cable outlet box from the Power Module, RPM Gating to the Gating Equipment Console, not to exceed 75'-0" (22,860) in length. This cable is provided by Varian and installed by the Customer.

64.322

If conduit is required, provide 1 1/2" (38) diameter conduit. The distance from the Power Module, RPM Gating to the Respiratory Gating Camera not to exceed 20'-0" (6096).

69 - Power Receptacles / Switches

69.177

Provide a grounded 120V 60Hz (240V 50Hz) duplex power receptacle at the Power Module, RPM Gating (011). Locate within 12" (300) of the Power Module, RPM Gating.

69.302

Provide a dedicated, standard wall switch for the Power Module, RPM Gating power outlet.

	[000] Refer to the Varian Components Table.	Respiratory Gating Installation Typical Clinac Treatment Room				
	Not For Construction					
G.1.1 :page	planning dept.	© Varian Medical Systems 2001 All rights reserved	24Jan08	revision: 3	doc. #: 200001	page: G.1.1

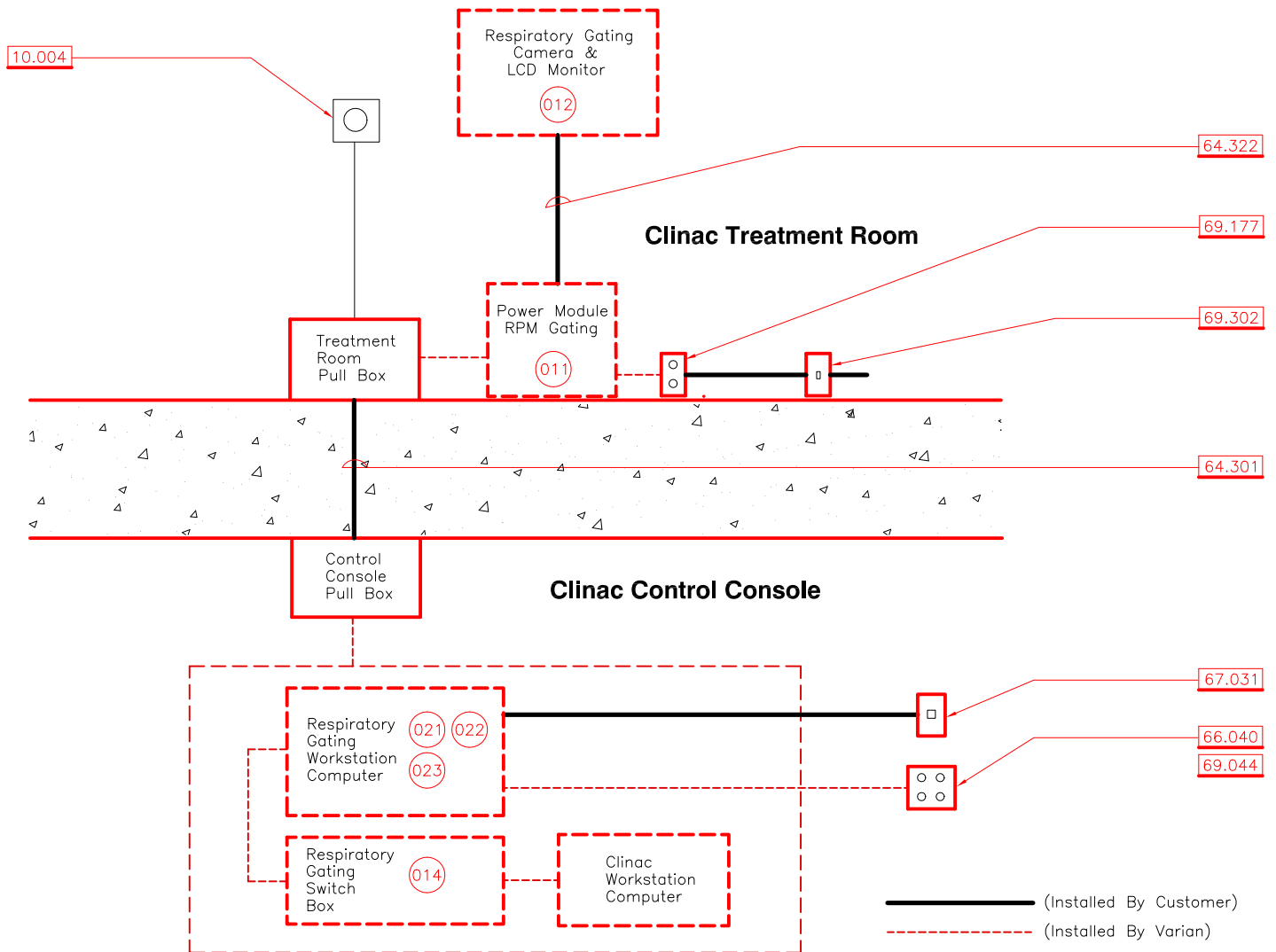

Respiratory Gating Components							
Key	Equipment	Height inch (mm)	Width inch (mm)	Depth inch (mm)	Weight lb (kg)	Max Watts	Max dbA
011	Power Module, RPM Gating	12 (305)	10 (254)	6 (152)	13.5 (6)	n/a	n/a
012	Respiratory Gating Camera & Brkt.	11.5 (292)	6 (152)	8 (203)	7 (3)	100	n/a
013	Respiratory Gating Camera & Brkt. (CT)	23 (584)	18.5 (470)	9.5 (241)	8 (3.6)	100	n/a
014	Respiratory Gating Switchbox Assembly	2.4 (61)	6.9 (175)	4.8 (122)	1 (0.5)	n/a	n/a
021	Workstation Keyboard	2 (51)	19 (483)	8 (203)	4 (2)	n/a	n/a
022	Workstation Computer	19 (483)	8 (203)	17 (432)	27 (12)	240	n/a
023	Workstation Monitor	20 (508)	22 (559)	4 (102)	18 (8)	n/a	25

10.124

IDP200003

	Refer to the Varian Components table.	Respiratory Gating Installation Clinac Interconnect Wiring				
	Not For Construction					
G2.0 :page	planning dept.	© Varian Medical Systems 2004 All rights reserved.	24Jan08	revision: 3	doc. #: 200002	page: G.2.0

10 - General Notes

10.004

Audio prompts are available on the output jack of the Gating Workstation (1/8" audio connector, 1 vrms full scale output voltage). The customer shall provide all wiring, amplification and speakers required to provide audio to the patient. The speaker wiring can be run to the treatment room pull box, to the control console pull box. The speaker should be mounted in close proximity to the treatment couch. (wall or ceiling mount)

10.124

The layouts shown on IDP drawings represent typical treatment room plans. Clearances and wall thicknesses vary.

64 - Cable Access Runs

64.301

Provide 1" (25) cable conduit with a standard computer signal cable outlet box from the Power Module, RPM Gating to the Gating Equipment Console, not to exceed 75'-0" (22,860) in length. This cable is provided by Varian and installed by the Customer.

64.322

If conduit is required, provide 1 1/2" (38) diameter conduit. The distance from the Power Module, RPM Gating to the Respiratory Gating Camera not to exceed 20'-0" (6096).

66 - Circuit Breakers / UVRs

66.040

Provide 20 amp at 120 Vac or 10 amp at 240 Vac dedicated circuit breakers for auxiliary equipment.

67 - Communications

67.031

Provide network cabling outlets at all server or workstation equipment locations. All network cabling must be in place and tested prior to equipment installation. Network patch panels, hubs and routers are typically located in a server room or closet.

69 - Power Receptacles / Switches

69.044

Provide a grounded 4 plex electrical power receptacle for Gating option components. Locate adjacent to the underside of the counter to provide maximum power cable extension room.

69.177

Provide a grounded 120V 60Hz (240V 50Hz) duplex power receptacle at the Power Module, RPM Gating (011). Locate within 12" (300) of the Power Module, RPM Gating.

69.302

Provide a dedicated, standard wall switch for the Power Module, RPM Gating power outlet.

	[000] Refer to the Varian Components Table.	Respiratory Gating Installation Clinac Interconnect Wiring				
	Not For Construction					
G.2.1 :page	planning dept.	© Varian Medical Systems 2001 All rights reserved	24Jan08	revision: 3	doc. #: 200002	page: G.2.1

Ceiling Mount

OR

Wall Mount

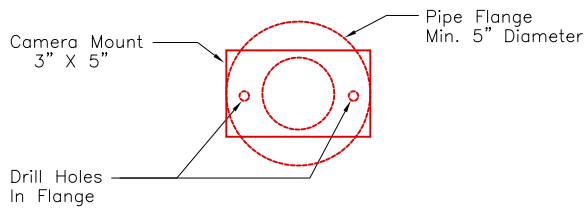
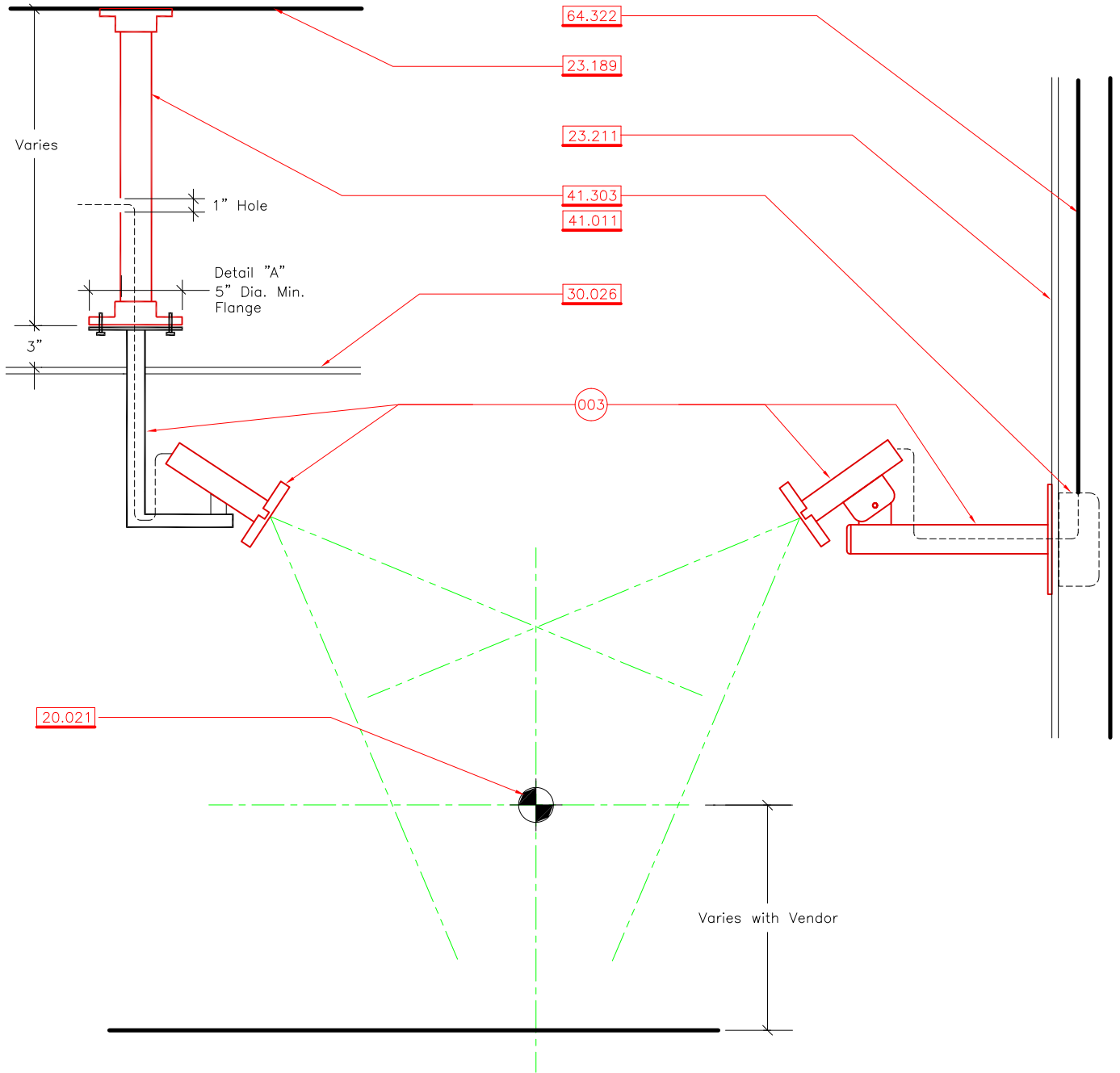

Detail "A"

N.T.S.

A Respiratory Gating Camera - Typical Mounting Installation for Clinacs, Acuity and Ximatrons

IDP200010

	Refer to the Varian Components chart at the end of this section.	Respiratory Gating Installation Camera Mounting Details				
	Not For Construction					
G.9.0 :page	planning dept.	© Varian Medical Systems 1999 All rights reserved.	24Jan08	revision: 2	doc. #: 200007	page: G.9.0

20 - General Layout Notes

20.021

Isocenter - This is the primary reference point for Varian equipment. Show the isocenter location clearly on all relevant drawings. Maintain the isocenter location on site by extending perpendicular axis lines along slab and up walls in all four directions. The isocenter heights for Varian systems fall within 4'-2" to 4'-4.5". (1267 to 1330) The installed Gating Camera location shall be the same location in the Simulator and Clinac treatment rooms.

If using gating with a Non-Varian machine, verify isocenter with specific vendor.

23 - Dimension Descriptions

23.189

This is the line of the shielding barrier.

23.211

This is the recommended dimension to concrete. Recommended face of concrete dimensions assume up to 6"(150) of wall furring.

30 - Finishes

30.026

Exposed grid ceilings allow for access to the power supply without the use of access doors. Service at the equipment is simplified where there are removable ceiling tiles. Coordinate the layout of ceiling tile to insure that ceiling support system does not interfere with the camera support and bracket.

41 - Component Anchorage Brackets

41.011

If equipment is to be anchored to a wall or ceiling, provide appropriate structural backing. Camera mounting bracket (by Varian), bracket support (by Customer). Install per bracket manufacturer's instructions. Verify mounting height with local codes and other requirements described in the IDP for this product.

41.303

The Gating Camera can be mounted either from the ceiling or on the wall per the customers preference. The Installation Data Package (doc. #: 200007) contains mounting details for either option.

64 - Cable Access Runs

64.322

If conduit is required, provide 1 1/2" (38) diameter conduit. The distance from the Power Module, RPM Gating to the Respiratory Gating Camera not to exceed 20'-0" (6096).

	[000] Refer to the Varian Components Table.	Respiratory Gating Installation Camera Mounting Details				
	Not For Construction					
G.9.1 :page	planning dept.	© Varian Medical Systems 2001 All rights reserved	24Jan08	revision: 2	doc. #: 200007	page: G.9.1

Respiratory Gating Pre-Installation Checklist

In accordance with current Varian "Standard Terms and Conditions of Sale" RAD 1652, para. 15 16, the following are the minimum facility requirements to be accomplished before the shipment of your System can begin. Request for any exceptions should be referred to your Varian Regional Installation Coordinator. The Customer is responsible for having the building, utilities, lighting, ventilation, air conditioning, mounting facilities, all necessary radiation shielding, and access to the room completed by the day of final inspection. If delays in completion delay installation, the Customer shall reimburse Varian at Varian's standard service rates for any extra time and /or travel by Varian made necessary by the delay. I have explained these requirements to the Customer on this date along with the specific requirements listed below.

Site: _____ Equipment Type: _____ SN: _____ Date: _____

Y N ARCHITECTURAL REQUIREMENTS

- 1. Installation drawings reviewed by Varian
- 2. All required permits complete

GENERAL RPM GATING REQUIREMENTS (ALL SYSTEMS)

- 3. Adequate Console space provided for RPM WS & Monitor for each RPM system (Clinac, SIM, CT)
- 4. Console area(s) finished and ready for installation
- 5. RPM installation areas sealed from construction dust particles
- 6. Network port provided in each Console area near RPM WS
- 7. Duplex AC outlet provided within 4'-0" (1200) of RPM Power Module box mounting location and dedicated power switch provided for each RPM system room
- 8. Nearby operational film processor available for use
- 9. Qualified physicist available for CAP testing (approx. 4 hrs per installed unit)
- 10. Storage space available for shipment receipt (10 sq. ft)
- 11. Provisions made for removal of shipping crates, boxes and packing material
- 12. Stereo Speakers wired and installed for each RPM system (customer option and responsibility)
- 13. If existing RPM Gating systems are installed, software versions are listed in the Notes (for possible upgrades)
- 14. Telephone available in Clinac Console area

CLINAC REQUIREMENTS IF SECTION IS N/A

- 15. Conduit - 1" (25) with standard signal cable outlet boxes provided from Console RPM computer area to RPM Power Module box, not to exceed 75'-0" (22,860)
- 16. Conduit - 1.5" (37) with standard signal cable outlet boxes provided from RPM Power Module box to RPM Gating Camera, not to exceed 20'-0" (6096)
- 17. RPM Camera/LCD Monitor mounting bracket firmly installed over conduit box opening
- 18. Distance from Camera mounting bracket to Clinac Isocenter is $\leq 14'-0"$ (4200)
- 19. RPM Power Module box installed in Treatment room

Y N SIMULATOR REQUIREMENTS IF SECTION IS N/A

- 20. Conduit - 1" (25) with standard signal cable outlet boxes provided from Console RPM computer area to RPM Power Module box, not to exceed 75'-0" (22,860)
- 21. Conduit - 1.5" (37) with standard signal cable outlet boxes provided from RPM Power Module box to RPM Gating Camera, not to exceed 20'-0" (6096)
- 22. RPM Camera/LCD Monitor mounting bracket firmly installed over conduit box opening in Simulator room
- 23. Distance from Camera mounting bracket to Clinac Isocenter is $\leq 14'-0"$ (4200)
- 24. List Customer's Simulator Fluoro Video Standard: _____
- 25. RPM Power Module box installed in Simulator room
- 26. 3rd Party Simulators: required RPM interface cables and modules are properly installed locations or customer has arranged installation by vendor

CT SIMULATOR REQUIREMENTS IF SECTION IS N/A

- 27. List manufacturer & model of CT Simulator in Notes below
- 28. Conduit - 1" (25) with standard signal cable outlet boxes provided from Console RPM computer area to RPM Power Module box, not to exceed 75'-0" (22,860)
- 29. Conduit - 1.5" (37) with standard signal cable outlet boxes provided from RPM Power Module box to 'curtain rail' location, not to exceed 20'-0" (6096)
- 30. Cables routed through ceiling and to the base of the CT Simulator Gantry (if required)
- 31. Couch Camera bracket available and couch is 'ready' to attach bracket
- 32. Camera storage mounting bracket installed on wall (customer responsibility)
- 33. "Curtain rail" or cable take-up mechanism provided and installed for Camera cable (customer responsibility)
- 34. RPM Power Module box installed in Simulator room
- 35. Required RPM interface cables and modules are properly installed or customer has arranged installation by vendor

Notes: _____

Project Manager Signature: _____

Varian Representative

Customer Representative

Final Inspection Date

January 2008

200010

Page G.10

Exhibit B
Replacement Equipment

[See Attached]



Versa HD



ELEKTA

Versa HD™

The convergence

of conventional radiotherapy with

advanced stereotactic precision.

Versa HD is not available for sale or distribution in all markets. Please contact your Elekta representative for details.

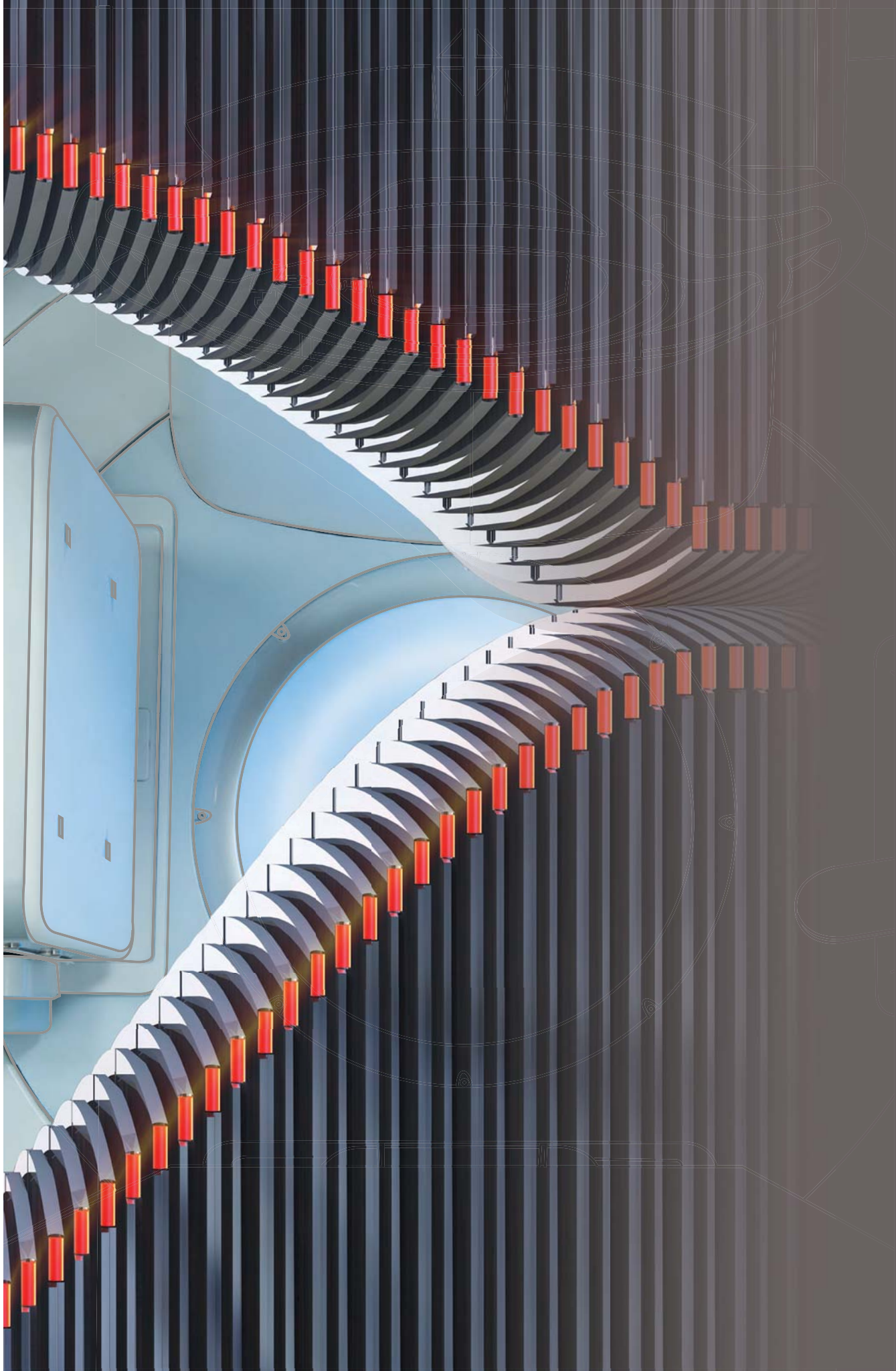

One Solution. Unlimited Possibilities.



Versa **HD**

One Solution. Unlimited Possibilities.



Versa HD™

A single delivery system with **unmatched versatility**

Recognizing the emergence of increasingly advanced therapies combined with unprecedented demands to maximize health care resources, Elekta is pleased to introduce Versa HD™.

Providing the flexibility to safely and efficiently deliver the full spectrum of conventional radiotherapy techniques, Versa HD advances modern cancer care with the added versatility to deliver sophisticated linear accelerator-based stereotactic treatments – all within a single delivery system.

New standards in **treatment efficiency**

Elekta's new and innovative High Dose Rate mode leverages the latest advances in flattening filter-free beam technology and provides maximum dose rates three times higher than previous generation Elekta linear accelerators. With the option to deliver conventional and high dose rates, Versa HD enables highly sophisticated therapies without compromising treatment times.



Versa HD

One Solution. Unlimited Possibilities.

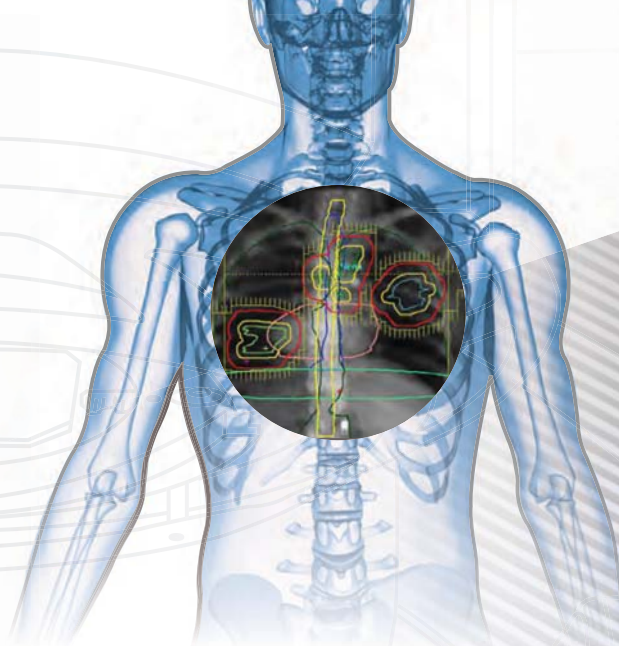

Superior **target conformance**

Versa HD features Agility™, Elekta's revolutionary multi-leaf collimator. Agility utilizes 160 fine-resolution leaves, a 40 cm x 40 cm treatment field and leaf speeds more than two times faster than other MLC systems. The patented Rubicon™ leaf-positioning technology of Agility verifies leaf movement in real time, providing extreme precision, high reliability and enhanced conformance for a broad range of cases.

The full potential of **High Dose Rate delivery**

With Versa HD, the unique combination of ground-breaking MLC leaf speeds with High Dose Rate mode means clinicians can, for the first time, explore the full capabilities of high dose rate delivery and take advanced therapies such as VMAT, SRS and SRT to new levels.

VersaHD™

Precision

Versa HD™

Soft tissue imaging during delivery

With the ability to image during treatment delivery, Versa HD provides an opportunity to reduce treatment time-slots to improve clinical efficiency. Combining imaging and treatment delivery also reduces the likelihood of patient movement and changes in internal organ position during the treatment session. This means that patient care is further enhanced while giving clinicians the flexibility to provide a patient-specific workflow.

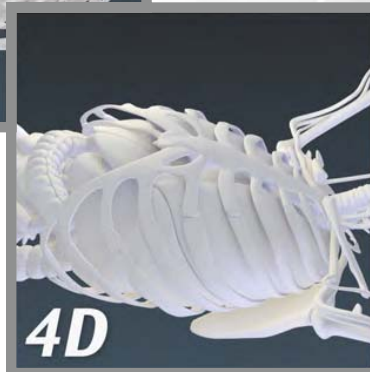
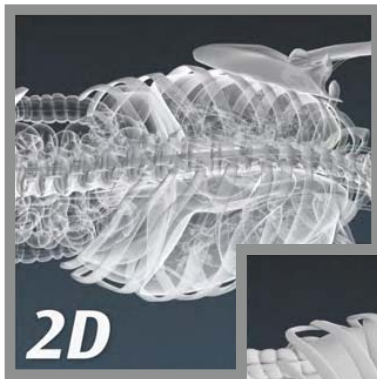



Anatomically correlated **4D imaging**

Unique to Elekta, Versa HD delivers state-of-the-art 4D soft tissue visualization to manage respiratory motion and accurately target mobile lung tumors – a difficult task before the introduction of this advanced technology. 4D image guidance technology allows clear visualization of moving targets to enable margin reduction to set new standards in lung treatment.

Integrated care management for radiation and medical oncology

Versa HD is supported by Elekta's integrated software solutions to deliver immediate access to clinical and patient information. Rapid access to this data enables multi-disciplinary teams to make more informed treatment decisions. MOSAIQ enables clinicians to effortlessly coordinate the patient's entire continuum of oncology care. Through a powerful combination of clinical and patient data available at the user's fingertips, personalized treatments can be created across multiple modalities specific to each patient's disease. Advanced workflow customization and automation supports faster, more effective patient throughput, leading to greater efficiency and a paperless practice.

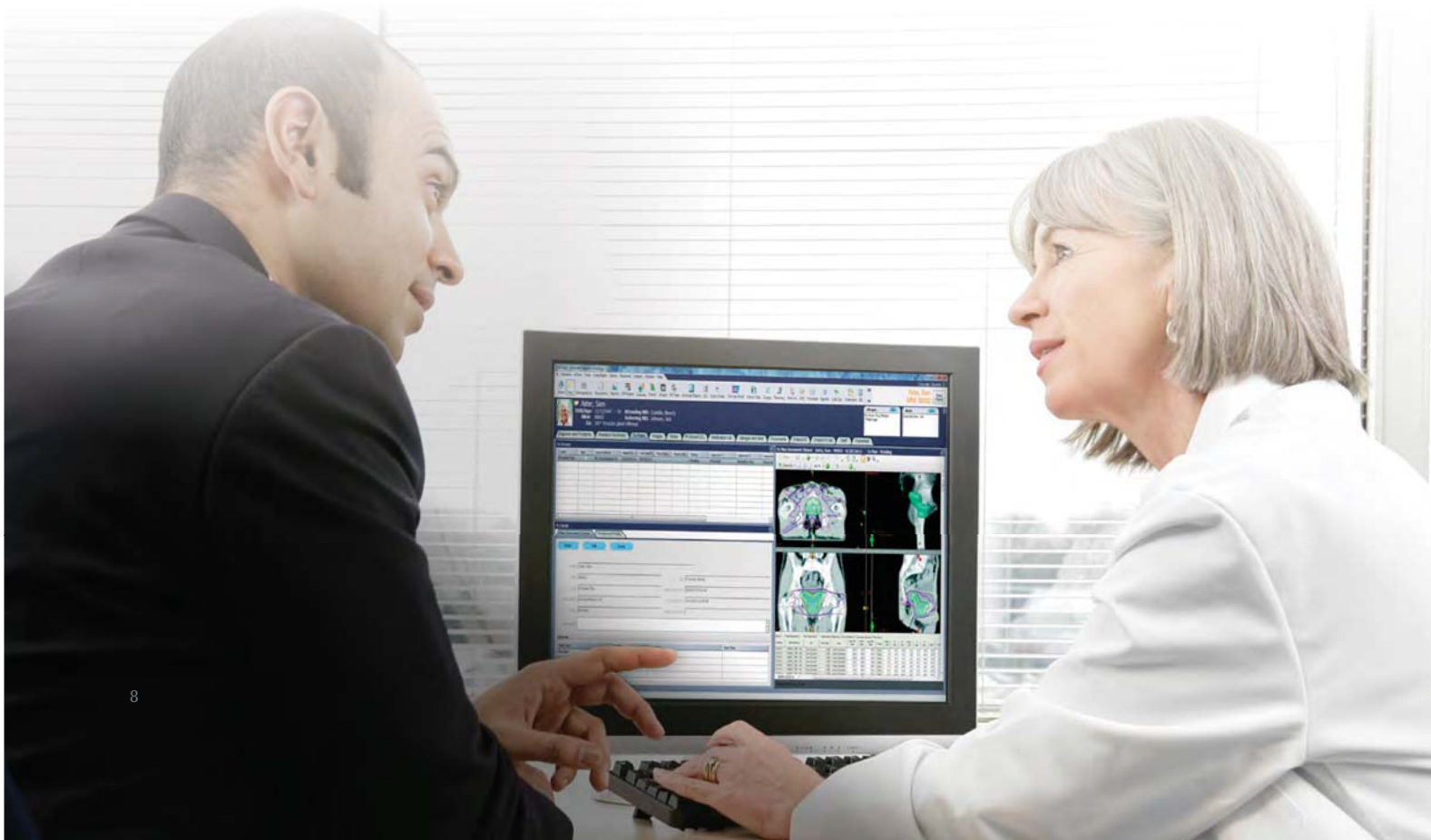

Precision plans for all major treatment techniques

With sophisticated tools to make planning easier, reproducible and clinically reliable, Monaco® redefines treatment precision and conformance, enabling the delivery of the most advanced 3D CRT, IMRT, VMAT and SBRT therapies. Powered by the Monte Carlo algorithm, the most accurate dose calculation currently available, Monaco leads the way in dose conformity, delivery efficiency and sparing of organs-at-risk. Combining these capabilities with modern architecture technology, Monaco sets a new standard in accuracy and speed, reducing planning and treatment times and improving plan quality.

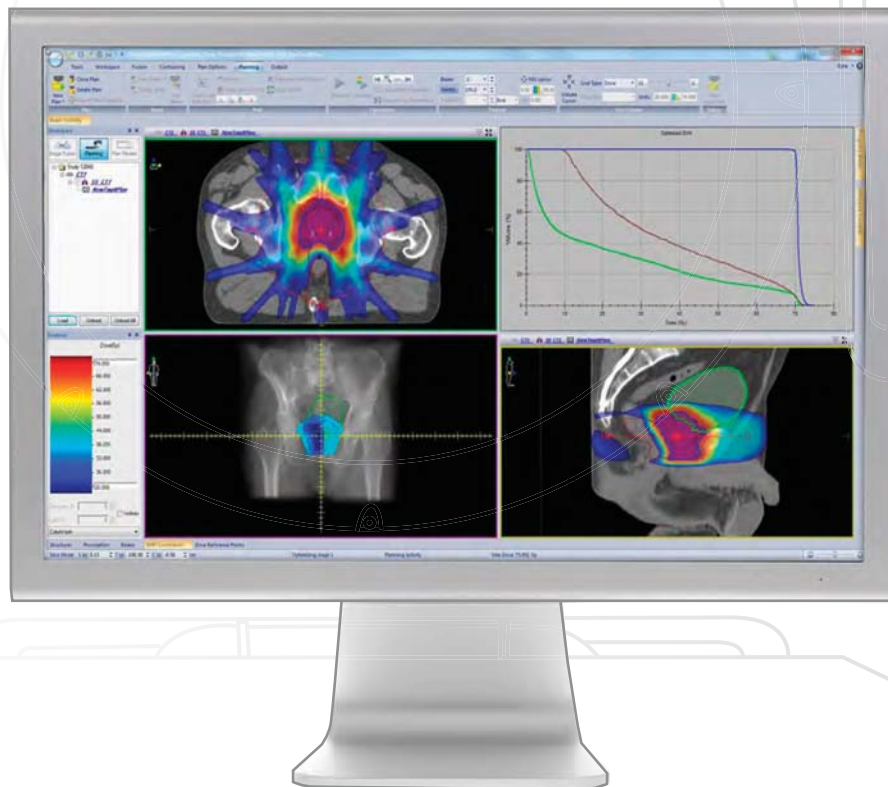

VersaHD™

Custom configurable for unique clinical needs

Versa HD is supported by a series of packages designed to address unique clinical challenges, making it easy to customize a system that meets your specific needs and those of your patients.

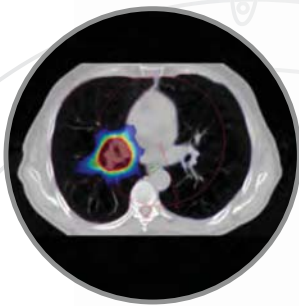

Lung

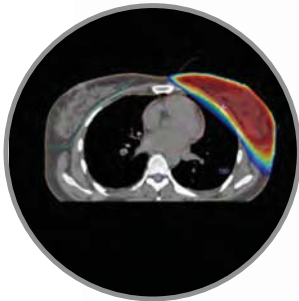

Breast

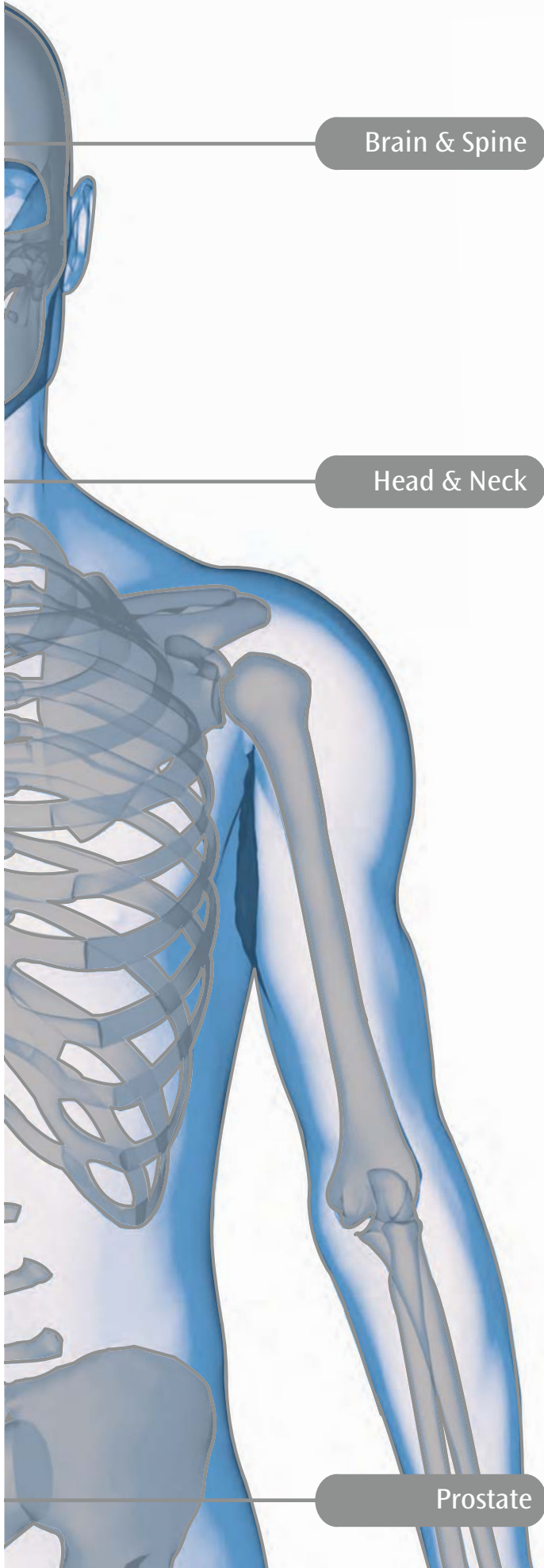

Brain & Spine

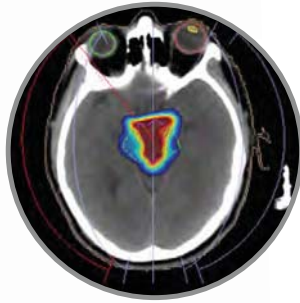

Head & Neck

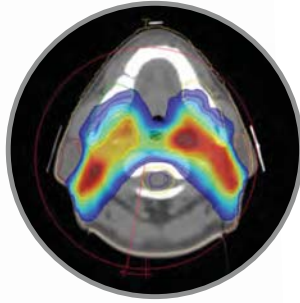

Prostate

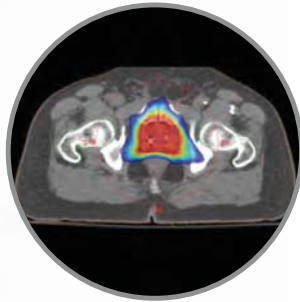



Versa HD™

Safety by design

Versa HD was designed with patient safety in mind:

- ◆ Decrease collision risks with touch-activated patient protection and the market's largest isocenter clearance
- ◆ Reduce non-therapeutic doses with the lowest radiation transmission of any commercially available MLC
- ◆ Visualize broad regions-of-interest with the industry's largest IGRT cone-beam CT field-of-view
- ◆ Audit and safely orchestrate multiple linac functions with Elekta's seventh generation digital control system



Confidence



Versa HD™

Elevated **patient experience**

Versa HD is designed with new ergonomic features and softer streamlined shapes, creating a confident and relaxed treatment environment. Combining low mechanical noise with ambient lighting effects, Versa HD was designed with patient comfort in mind.

Real-time **remote system monitoring**

Elekta Remote Services proactively monitors key system functions in real time and provides notification of potential problems before they occur. With more than 25 years of digital linear accelerator expertise, Elekta provides Versa HD users with fewer delays and reduced downtime.



Versa **HD**

Experience



www.VersaHD.com

www.VersaHD.com

www.elekta.com

Corporate Head Office:

Elekta AB (publ)
Box 7593, SE-103 93 Stockholm, Sweden
Tel +46 8 587 254 00
Fax +46 8 587 255 00

info@elekta.com

Regional Sales, Marketing and Service:

North America

Tel +1 770 300 9725
Fax +1 770 448 6338

info.america@elekta.com

Europe, Middle East, Africa,
Eastern Europe, Latin America
Tel +46 8 587 254 00
Fax +46 8 587 255 00

info.europe@elekta.com

Asia Pacific

Tel +852 2891 2208
Fax +852 2575 7133

info.asia@elekta.com

Human Care Makes the Future Possible



ELEKTA

Exhibit C
Cost Summary

Item		Cost
Land	Existing	N/A
Equipment	Elekta VersaHD Linear Accelerator	\$1,350,000.00
Construction		\$327,000.00
Sales Tax	8%	\$134,400.00
Contingency	7%	\$117,390.00
Professional Fees	Legal	\$30,000.00
Total Project Cost		\$1,958,550.00

Exhibit D

Documentation Supporting Costs

[See Attached]



January 28, 2021

Christopher Radcliffe
Genesis Care of Florida
2270 Colonial Blvd.
Fort Myers, FL 33907

Re: 215 Beaman St. Clinton, NC 28328 Linear Accelerator Change Out

We are pleased to present you with this proposal for the above referenced project. Our proposal is predicated upon costs from previous linear accelerator change outs and information received to date.

General Conditions – 1 month	\$38,577.00
Existing Conditions/General Requirements	\$17,160.00
Concrete/Grade Beam Replacement	\$20,000.00
Casework	\$25,000.00
Doors & Hardware	\$ 1,236.00
Framing/Drywall and ACT	\$12,000.00
Flooring	\$ 9,000.00
Painting	\$ 4,000.00
E-Frame, Raceways	\$29,000.00
Plumbing/HVAC	\$65,000.00
Electric	\$60,000.00
Permits and Inspections	\$ 2,200.00
Insurance & Taxes	\$ 4,031.00
Fee	\$29,317.00
Construction Contingency	\$10,000.00

Base Bid Total Construction \$326,521.00

We anticipate the work to be substantially complete in approximately 1 Month. Scope of work is limited to only such work as is required to modify the existing vault to accommodate the new Elekta Equipment. Scope of work does not include any modifications to the Vault's size, shape, structure, or shielding. It is assumed that the Building's Fire Protection, Plumbing, HVAC and Electrical Systems are adequate to meeting requirements of the new equipment and are code compliant. Should you have any questions or comments, please do not hesitate to call.

Sincerely,

Dave Kovalik
Vice President – Div. Mgr. Detroit

**BUILT
ON DD
SAFETY**

deangelisdiamond.com

Naples, FL
6635 Willow Park Drive
Naples, FL 34109
o: 239.594.1994

Fort Myers, FL
8695 College Parkway
Suite 2042
Fort Myers, FL 33919
o: 239.594.1994

Sarasota, FL
2604 Cattlemen Road
Suite 404
Sarasota, FL 34232
o: 941.952.3846

Birmingham, AL
1800 International Park Dr.
Suite 205
Birmingham, AL 35243
o: 205.977.7798

Nashville, TN
2179 Edward Curd Lane
Suite 202
Franklin, Tennessee 37067
o: 615.922.3995

Detroit, MI
39555 Orchard Hill Place
Suite 235
Novi, MI 48375
o: 248.513.6112

the
honor
to
build

The following are assumptions and clarifications that have been made in our proposal based the Architectural Design documents as mentioned in the deliverable. No cost or time has been accounted for in the estimate to address the issue of any items identified as “**excluded**”. Changes to the following will result in a modification to the budget and may require revisions to the project schedule.

GENERAL CLARIFICATIONS

1. Note: We have included a construction contingency of \$10,000 in our number.
2. We have included the E-frame, Elekta Raceway, Brain Lab raceway/floor boxes per Finn Industries quote based on assumption from previous jobs.
3. Work to be performed on straight time during standard hours of operation.

INSURANCE

1. General Liability Insurance is included at a rate of 1.25% of the total project volume. General Liability Insurance will be billed in its entirety at the beginning of the project.

DIVISION 00 AND 01 GENERAL CONDITIONS

1. Costs required to construct the project, including:
 - a. Onsite Supervision
 - b. Toilet facilities at job office
 - c. Daily clean up
 - d. Dust barriers
 - e. Safety
 - f. Reproduction costs for bid and construction documents
 - g. Dumpsters (2) and clean up
 - h. Final Cleaning

DIVISION 02 DEMOLITION/CONCRETE

1. Remove and dispose of the following: partitions, doors, millwork, flooring, acoustical ceiling/grid, ductwork, plumbing fixtures and piping, flooring adhesive, interior concrete slabs. Slabs assumed to be 12” thick.
2. We have included an allowance for concrete pour back.

DIVISION 03 MILLWORK

1. Furnish and install plastic laminate base and upper cabinets with solid surface countertops in the following areas:
 - a. Control room cabinets and counter tops
 - b. Treatment room cabinets and countertop

DIVISION 08/09 DOORS/HARDWARE, FINISHES

1. We have included any fire caulking of penetrations through walls, but have not included any fire spray of structural components of building.
2. (2) welded hollow metal frames, (2) wood doors to match existing, (2) passage hardware sets

- a. NOTE: Lead time on wood doors is approximately (8-10) weeks
- 3. Apply (1) coat of drywall primer to all new drywall, apply (2) coats of eggshell finish coat to all new drywall, apply (1) coat of flat finish to gypsum ceilings to receive paint.
 - a. We have not included any wall coverings.
- 4. Metal stud interior walls to be 20 gauge. Gypsum board finish to level 4.
- 5. Unfaced fiberglass insulation in interior walls
- 6. Acoustical ceilings and grid included per Genesis Care standard.

DIVISION 22/23/26 – PLUMBING, HVAC, ELECTRICAL

- 1. Plumbing:
 - a. Wall mounted accessible sink with accessories.
- 2. HVAC:
 - a. Furnish and install new Drake Chiller
 - b. Existing ACCU to remain.
 - c. Start up, testing and balancing included
- 3. Electrical:
 - a. Allowance based on previous experience and costs with projects

EXCLUDED ITEMS

To further clarify the scope above, the following items are **excluded** and/or are by Owner. This is not intended to be a complete listing of Owner costs.

- 1. Unforeseen conditions
- 2. Permit/Inspection fees
- 3. Design/Architectural fees – separate contract - DB
- 4. 3rd party inspections/equivalent to CON requirements
- 5. Testing
- 6. Arc Flash coordination and study
- 7. Fire Alarm – reuse existing. Assumed no new devices are required.
- 8. Fire Sprinkler work
- 9. Asbestos survey/abatement
- 10. Wall coverings
- 11. Computer cabling and equipment
- 12. Phone/data cabling and equipment
- 13. Security/Access controls
- 14. Building Management System
- 15. Radiation Shielding – by owner
- 16. Brain Lab Equipment – by owner
- 17. Floor boxes by others



Quotation number: 2021-313971-RA

Quotation Date: February 04, 2021

Date: February 04, 2021

Quotation

Prepared for:

21ST Century Onc NC Clinton
ACCOUNTS PAYABLE 215 BEAMAN
ST
CLINTON, North Carolina 28328-2905
United States

Prepared by:

Robby Adams
Healthcare Sales Director - Linac
400 Perimeter Center Terrace, Suite 50
Atlanta GA 30346
(t) +1 770 670 2503
(c) 404-513-3260
robby.adams@elekta.com

Elekta is pleased to submit the following Quotation for the products, software licenses, and/or services as described herein at the prices and terms stated.

The estimated pricing set out in this Quote shall expire September 03, 2021

Hardware and/or Software Price

Description	Currency	Price
Total List price (*)	USD	\$7,155,228.79
Total Discount (*)	USD	\$5,805,228.80
Total Price (*)	USD	\$1,350,000.00

* Excluding Taxes

For U.S. customers, this purchase is subject to the discount provisions of the federal anti-kickback statute, 42 U.S.C. § 1320a-7b(b), and the discount safe harbor regulations at 42 C.F.R. § 1001.952(h). In accordance with such provisions, Customer shall fully and accurately report all prices paid net of discounts where appropriate, and as appropriate, in the costs claimed or charges made under any Federal or State healthcare program, and provide information upon request to Medicare, Medicaid and other applicable federal and state health care programs on all discounts and price reductions received from Supplier.

Price Payment Schedule

Unless otherwise agreed, all fees shall be due and payable in full upon final signature of an agreement. State, local, VAT and other taxes, and import/export licenses are not included in this Quotation.

Software

Unless otherwise agreed, the license fee for the Software embedded in the Hardware is included in the Price set forth above.

Delivery Date

Delivery date for the Deliverables is estimated to be within 120 days from date of agreement subject to payment of fees due. Delivery term shall be CIP Site as defined in Incoterms 2010.

Pricing confidentiality

This Quote and the pricing terms set out herein are negotiated between the Customer and Supplier and may be unique to the Customer. Therefore, and except as otherwise provided by law, Customer hereby agrees to keep the pricing arrangement confidential for a period of no less than three (3) years from the date signed quote. Customer will not use this Confidential Information in furtherance of its business, or the business of anyone else, whether or not in competition with the Supplier.

Purchase Order: _____

EXHIBIT A

Scope of Supply for Hardware and/or Software

Qty	Description
1	<p>Elekta Versa HD™ Versa HD™ provides:</p> <ul style="list-style-type: none"> • Digital accelerator with exclusive cover set design; • Agility™, Elekta's integrated multi-leaf collimator that provides full field high resolution beam shaping (5mm at isocentre), a 40 x 40cm treatment field and effective leaf tip speed of up to 6.5cm/sec, capable of covering multiple targets with interdigitation and island shapes; • 6MV and 10MV flattened energies delivered as standard; • A broad spectrum of delivery techniques from 3D Conformal Radiotherapy to IMRT, VMAT and SRT techniques; • XVI, offering 2D and 3D kV image guidance for advanced soft tissue visualization supporting image guided treatment workflows, XVI Software options VolumeView™, MotionView™ and PlanarView™ are included; • iViewGT™, offering 2D MV imaging capability supporting image guided treatment workflows. • IntelliMax™ Intelligent Agent license is included. Any provision of services relating to the use of data collected by the Agent (via the IntelliMax Enterprise) should be negotiated as part of the Service Contract between the Customer and the BU/distributor. IntelliMax Intelligent Agent requires a dedicated PC. Provision of this PC must be negotiated between the Customer and the Elekta BU/Distributor. A specification of the PC can be obtained from your Elekta representative. IntelliMax Intelligent Agent also requires a direct internet connection to the Agent PC opening secure port 443 (https).
1	<p>Stereotactic MV Isocenter Setup Service to evaluate the MV (Gantry), and combined MV (Gantry) and table isocenter using software tool based on the Winston Lutz test. The following values will be achieved at 6 MV;</p> <ul style="list-style-type: none"> • MV isocenter (Gantry): ≤ 0.7 mm radius • Combined MV isocenter (Gantry) and table isocenter: ≤ 1.1mm radius.
1	<p>Goalpost Assembly Elekta Synergy® Platform, Elekta Synergy®, Elekta Infinity™, Elekta Axesse™ and Versa HD™ compatible standard goalposts.</p>
1	<p>Versa HD standard cover set.</p>
1	<p>High Dose Rate Mode Hardware Upgrade Kit</p>
1	<p>6MV High Dose Rate Software License High Dose Rate Mode provides flattening filter free beam delivery of 6MV beams at dose rates up to 1,400 MU/min, as well as reduction in scatter, lowering whole body radiation doses.</p>
1	<p>10MV High Dose Rate Software License High Dose Rate Mode provides flattening filter free beam delivery of 10MV beams at dose rates up to 2,200 MU/min, as well as reduction in scatter, lowering whole body radiation doses.</p>
1	<p>6 MeV Electron Energy</p>
1	<p>9 MeV Electron Energy</p>
1	<p>12 MeV Electron Energy</p>
1	<p>15 MeV Electron Energy</p>
1	<p>U.S.A. Electron Flatness Electron flatness according to U.S.A. standards, optimized at 100 cm.</p>
1	<p>Aperture Plate Electron Beam Applicator 25 x 25 cm Fitted with spring loaded touch guard, coded end frames and electrical connection to linear accelerator. The X-ray diaphragms are then set automatically to the optimum position. A unique hook and latch mounting system enables easy and rapid attachment.</p>

Qty	Description
1	<p>Standard Set of Aperture Plate Electron Beam Applicators Field sizes:</p> <ul style="list-style-type: none"> • 6 x 6 cm, SSD 95 cm • 10 x 10 cm, SSD 95 cm • 14 x 14 cm, SSD 95 cm • 20 x 20 cm, SSD 95 cm <p>Fitted with spring loaded touch guard, coded end frames and electrical connection to linear accelerator latch mounting system enables easy and rapid attachment.</p>
1	<p>VMAT CAT (Volumetric Arc Therapy Customer Acceptance Test)</p>
1	<p>Response™ Gating Control System for Digital Accelerators Response provides a seamless interface that supports automated gated treatment delivery for a range of delivery techniques on the Elekta Digital Accelerator. The gating signal can be provided by a validated external motion management system, such as the Active Breathing Coordinator™.</p>
1	<p>SYNERGISTIQ™ Software License Enables the XVI functionality to support SYNERGISTIQ. SYNERGISTIQ integrates MOSAIQ® and XVI into a consolidated and synchronized user interface.</p>
1	<p>Software Media Pack, SYNERGISTIQ™ Clients</p>
1	<p>SYNERGISTIQ™ Monitor kit Specification for Extender/Receiver and cable for a remote monitor. Required for sites that use SYNERGISTIQ with a remote monitor in the treatment room.</p>
1	<p>kiloVoltage Cone-beam CT Hardware for Versa HD™</p>
1	<p>40kW kV generator - 480V The integrated 40kW kV generator provides multiple settings control via the XVI software. Acquisition parameters are configured within the preset protocol function in the XVI software, and is user configurable. The generator and X-ray tube have been optimized for the 3D VolumeView™ imaging, as well as the 2D radiographic type exposures of PlanarView™ and MotionView™.</p>
1	<p>Intrafraction Imaging License Provides the ability to acquire kV images during the delivery of an MV treatment field. Intra-fraction imaging allows you to:</p> <ul style="list-style-type: none"> • Acquire images (2D fluoro) for a specified time, and then move directly into a 3D volumetric acquisition. • Acquire a 3D volumetric image during conformal, IMRT or VMAT MV deliveries to measure intrafraction movement. • Perform Intra-fraction 3D or 4D volumetric imaging and registration per arc during dual (or multiple) arc procedures, allowing table corrections in between arcs.
1	<p>Symmetry™ License Symmetry is primarily indicated for respiratory motion management. It offers a unique 4D IGRT online solution that is correlated to internal organ movement. It facilitates for the planned dose to be delivered to the volume where the target spends most of its time in. This allows for margin reduction and baseline shift compensation, supporting treatment deliveries during free-breathing with no surrogates. The use of Symmetry does not require planning on a 4D reference CT.</p>
1	<p>Critical Structure Avoidance Critical Structure Avoidance allows the registration of two separate areas of anatomy, utilizing both the clipboard and the Shaped Registration Region of Interest. XVI software will calculate the relationship of both areas of anatomy to the proposed correction vectors and alert the user if the target has moved closer to the critical structures due to anatomical changes. The user can then choose to select a compromise between the two areas, or send the patient for re-planning.</p>
1	<p>3D Automated Seed Match License Offers an optimized 3D registration algorithm to register implanted markers, without compromising on 3D volumetric information.</p>
1	<p>Hounsfield Units Hounsfield Unit (HU) Scaling uses calibration measurements to calculate the HU mean accuracy to ±40 HU for the small field of view for specified imaging conditions. HU Scaling changes the pixel values for the 3D VolumeView images. HU calibration provides greater soft tissue detail, ensuring a more accurate picture of where dose is being delivered, aiding in critical structure avoidance.</p>

Qty	Description
1	<p>Distributed Review Distributed Review allows the sending of XVI CBCT data to MOSAIQ® for review at any MOSAIQ® workstation, as well as the primary XVI workstation. Pre-requisites:</p> <ul style="list-style-type: none"> • Distributed Imaging/Treatment • DICOM CT Export (+/- Auto DICOM CT Export).
1	<p>Distributed Imaging Distributed Imaging allows the transfer a patient between XVI systems without having to prepare the registration settings on the secondary XVI system, through MOSAIQ®.</p>
1	<p>Elekta XVI Basic Calibration Kit - Bearing Phantom Assembly Specially designed geometric calibration phantom for kV to MV isocentre alignment. Suitable for the XVI system with the iBEAM® evo couch top.</p>
1	MRT 9931 ADAPTOR KIT. PHANTOM
1	<p>XVI Daily QA Phantom Kit Daily QA Phantom for kV and MV projection imaging and kV VolumeView™. Checks the laser and light field coincide and additionally provides a spreadsheet for recording and analyzing trend results.</p>
1	<p>XVI Water Calibration Kit Water phantom calibration kit for XVI calibration. It provides a reduction in CBCT image ring artefacts in addition to image quality improvements.</p>
1	<p>VolumeView™ Contrast phantom QA phantom to enable measurement of high resolution and contrast resolution and other image quality parameters of the VolumeView images acquired on the XVI workstation.</p>
1	2D TEST OBJECT, MRT 10321
1	<p>DICOM 4D export 4D DICOM export allows the user to export to a third party system the CBCT data as generated by Symmetry™ of:</p> <ul style="list-style-type: none"> • Average phases • All phases • Single phase.
1	<p>Archive and retrieve to network Performs automatic archiving of patient images to a pre-defined network location, outside of MOSAIQ®. Archiving can be scheduled, and the network location can be specified at will. The same tool performs retrieval of files from the same location.</p>
1	<p>Versa HD™ iViewGT™ This kit contains all of the components for iViewGT including;</p> <ul style="list-style-type: none"> • A MK 6 imaging control system cabinet with the iViewGT software R3.4.1. pre-installed. • A rigid and fully retractable slim line MV imaging detector arm with a large, square active detector area and wide lateral and longitudinal movement adjustments. The arm has automatic and manual arm movements and is fully interlocked.
1	iViewGT™ R3.4.1 Installation Kit
1	iViewGT™ R3.4.1 Software License
1	<p>iViewGT™ R3.4.1 Software License Collation Third Party License toolkit necessary for supporting iViewGT.</p>
1	<p>Remote Retraction of the iViewGT™ detector - 30M This kit allows Remote Retraction of the iViewGT detector from the Function Key Pad.</p>

Qty	Description
1	<p>DICOM 3.0 software interface for image transfer The international standard interface protocol for network transfer of medical images.</p>
1	<p>iViewGT™ IMRT Verification Software License This software expands existing iViewGT functions to verify multiple segment beams for IMRT. The iViewGT image acquisition is triggered automatically and the image taken depends on whether the user selects single, multiple or movie image.</p>
1	<p>Template Matching Software License The template matching option enables the user to compare the portal image with a nominated reference image for any set-up error. The set-up error is measured by matching visible anatomy and the field edge on the referenced image with the portal image. The user can move the templates to provide an image displacement.</p>
1	<p>Patient Auto Select Software License This enables the prescription selected on the Linac to automatically select or create that patient record on iViewGT™ or iViewC™ using the iCom-Vx protocol. In addition, images will automatically be acquired and stored in the iViewGT / iViewC database without further operator intervention.</p>
1	<p>Software License Image Approval This allows the user, assigned with the 'review' permission, to approve or disapprove any image within iViewGT™ or iViewC™.</p>
1	<p>Las Vegas Calibration Phantom The Las Vegas phantom is a device that is used to check image quality of a portal imaging device at different megavoltage energies both at acceptance and as part of the corrective maintenance procedure.</p>
1	<p>HexaPOD™ evo RT System with iGUIDE® 2.2 The system consists of:</p> <ul style="list-style-type: none"> • HexaPOD evo RT Couchtop with homogeneous carbon fiber couchtop • Handheld controller • iBEAM evo Extension 750 long • iBEAM evo Extension 415 • iBEAM Indexing bars • iGUIDE Reference Frame • EnableSwitch board • iGUIDE workstation • iGUIDE 2.2 software • iGUIDE tracking system • iGUIDE terminal • iGUIDE calibration Kit MIMI
1	<p>HexaPOD™ evo RT System Integration License This license package will provide the following integration features:</p> <ul style="list-style-type: none"> • Interface to MOSAIQ for automated patient ID and treatment site loading for departments using MOSAIQ 2.5 or higher. • Control of Precise Table with iGUIDE for Systems with Integrity 3.2.
1	<p>iBEAM® evo Extension 650 The iBEAM evo Extension 650 is designed to support the patients upper body and extends off the end of the iBEAM evo Couchtop by 650 mm, thus allowing for treatment of the prostate of very tall patient's.</p>
1	<p>Coded shadow tray assembly - Short Provides a means for attaching X-ray shadow blocks onto the head of the Linear Accelerator or Simulator. Comprising:</p> <ul style="list-style-type: none"> • Shadow tray assembly with hook and latch mounting, and multi-way plug connector • Two removable parallel transparent Perspex™ trays, one of which may be coded.
1	<p>Beam Block Tray - Star Pattern Lexan beam block tray with holes in a star pattern. Trays are designed with threaded, removable plugs for the coding of each block. Specially designed for use with the Elekta shadow tray assembly.</p>
1	<p>Hook and Latch Magnification Graticule Solid Frame Port Film magnification graticule that attaches directly to the linac, taking the place of the coded shadow tray, thus providing more clearance between the patient and the accessory. Used in treatment verification for situations where simultaneous fitment of blocking tray is not required.</p>

Qty	Description
1	<p>Electron Beam Field Shaping System For use with Electron applicators from Elekta and allows the user to easily provide Electron Beam field shaping. The system comprises:</p> <ul style="list-style-type: none"> • A Universal leveling template with an adjustable arm for securing styro-foam inserts- Set of five (5) rubber molds compatible with Elekta Electron applicators <ul style="list-style-type: none"> • 6cm x 6cm • 10cm x 10cm • 14cm x 14cm • 20cm x 20cm • 25cm x 25cm <p>Provided as part of the system is one (1) Hot Wire Cutter.</p>
5	<p>19-inch Control Room LCD Monitor</p>
1	<p>Extender Cards Extender cards for fault diagnosis on the Electrical Interface Module (EIM).</p>
1	<p>Customer Interface Terminal Board</p>
1	<p>Turbo Starter Kit for Linear Accelerators Ancillary equipment required for the installation and maintenance of any Precise Digital Accelerator. Comprising:</p> <ul style="list-style-type: none"> • Rotary vacuum pump • Turbo molecular pump attachment for rapid pump down times and higher roughing vacuum.
1	<p>Room Lasers, Green, Remote Set of 4 green room lasers with remote control adjustment. Comprising 3 crosshair and 1 line sagittal laser. Featuring fine lines (< 1mm), high precision adjustment at the isocenter and stable mounting bracket. Inclusive of switchable (110v to 240v) power supply and universal main adaptor.</p>
1	<p>Applications Training for Standard Therapy on the Desktop The 2-day Standard Precise Desktop Course (travel time inclusive) provides training for 4 Radiation Therapists in the clinical use of the Precise Desktop Digital Linear Accelerator. Successful participants will be equipped with the knowledge and skills to operate the system effectively. The course does not provide training in the principles or techniques used in Radiation Therapy.</p>
1	<p>Applications training for iViewGT™ The 3-day iViewGT training course (travel time inclusive), provides training for 4 radiation therapists in the clinical use of the iViewGT imaging system. Successful participants will be equipped with the knowledge and skills to operate the system effectively. The course does not provide training in the principles or techniques used in radiation therapy.</p>
1	<p>XVI Applications Training The 4-day XVI training course (travel time inclusive) provides training for Radiation Therapists in the clinical use of the X-ray Volume Imaging portion of the Elekta Digital Accelerators. Successful participants will be equipped with the knowledge and skills to operate the system effectively. The course does not provide training in the principles or techniques used in Radiation Therapy, CT, or Diagnostic Imaging. This course is given at the customer site for a maximum of 4 users.</p>
1	<p>HexaPOD™ evo RT System Training The 2-day HexaPOD evo RT CouchTop and iGUIDE® course (travel inclusive) provides training for 4 radiation therapists in the clinical use of the HexaPOD evo RT CouchTop and iGUIDE software. Successful participants will be equipped with the knowledge and skills to operate the system effectively. The course does not provide training in the principles or techniques used in radiation therapy.</p>
1	<p>Linac Labor Warranty</p>

Qty	Description
1	<p>Weekend Rigging & Handling Basic rigging of Linac to first floor or ground floor location outside of Elekta's normal working hours. Elekta will provide the necessary crew to offload, uncrate, rigging and machinery moving required to set system as per plan, and remove debris. Basic rigging excludes use of a crane or rigging down an elevator shaft. Standard Rigging includes:</p> <ul style="list-style-type: none"> • Make one pre-installation site visit and delivery project management. • Drill holes for equipment fasteners • Supply a 12,000 lb capacity forklift during the off loading procedure. • Stage and uncrate the linac machine, move all components into the facility, and set as directed. • Remove and dispose of all packaging that will not be reused. • Transport the base, gantry and beam arm into the facility/bunker on transport trolleys supplied by Elekta. • Set the base frame in place (Elekta will level). • Set the gantry drum onto the base frame. • Set beam arm into the gantry. • Install counterweight holder and stack the counterweights. • Supply a manual gantry lifting system to perform aforementioned setting activities and all necessary tools. • Supply a crew, including a rigging supervisor. • Include the cost of all associated resource and expenses, including related travel time. • Complete all rigging activities in a single day. <p>Standard Rigging excludes:</p> <ul style="list-style-type: none"> • Crane service. • Elevator, or shaft deliveries. • No clear access to the building (exterior). • Interior obstruction en route to treatment room. • Any shoring needed to protect the structure from the weight of the system. • Any shoring and/or plating needed to build temporary dock or landing area for the unit. • Extra long delivery routes, distances in excess of 150' from offload site to the treatment room. • Overtime, weekend, premium time, unless Weekend Rigging selected. • Additional travel expenses should the project exceed the time allotted in this scope for reasons beyond Elekta or our contractor's control. • Additional man-hours, manpower, travel expenses, or equipment required due to delays caused by incorrect site preparation, waiting time, or delays not caused by Elekta or our contractor will be itemized and billed to the customer at then current rates.
1	<p>iViewGT™ Amorphous Silicon detector panel for production systems.</p>
1	<p>Drayage</p>
1	<p>Linac Installation</p>
1	<p>Open Air Graticule The Open Air Graticule is intended to be used for Radiation Therapy to project a scale of defined increments on port film images which can aid in treatment setup and verification. The Open Air Graticule does not require the use of a shadow tray holder and can be attached directly to the head of the Precise Treatment System or SL Linac. It consists of two wires delineating the X & Y axis of the treatment field. This model of graticule is ideal for MLC customers and especially those using Elekta's iView & iViewGTTM. Because the open air graticule has a minimal transmission factor, with Physic's approval, the customer does not have to re-enter the treatment room after the port film to deliver the treatment. Please see product User manual for specific treatment information.</p>
6	<p>Education & Training Travel Support (4-6 day course) Elekta will provide reasonable and necessary travel to support completion of the Off-Site Education & Training course(s) purchased under this Agreement. This Travel Support includes reasonable and necessary airfare and accommodations booked at least three (3) weeks in advance through Elekta's approved travel agent, proof of course registration at the time of booking is required. Extended airfare and accommodations beyond the duration required to travel and attend the course(s) is not permitted. This Travel Support also includes reasonable and necessary local transportation costs and up to \$100 (USD) per person per day to cover reasonable and necessary meals, which will be paid by Elekta directly to Customer (not to Customer employees) upon receipt of invoice, proof of course completion and supporting receipts. This Travel Support is available for up to two (2) years after date of Acceptance, no exceptions permitted. Price - \$2,000.00 USD (ea)</p>
1	<p>Control System hardware for XVI R5.0.4 The XVI control system is a high specification PC which supports all aspects of the IGRT process including 2D, 3D and 4D kV image acquisition, reconstruction, and analysis using a suite of registration functionality.</p>
1	<p>XVI 5.0.4 Software Licenses</p>

Qty	Description
1	<p>Elekta Versa HD™ - Optional XVI Cassettes Provision of additional XVI collimators, in Elekta Versa HD colours, for Imaging. Includes:</p> <ul style="list-style-type: none"> • VolumeView cassettes: L10, M2, L2 • XVI Cassette holder.
1	<p>Closed Circuit TV System - Color The standard CCTV system consists of two Samsung SNP-5321 (1.3 Megapixel HD) dome-shaped color cameras and two pan/tilt/zoom control mounts allowing the operator full control of both cameras.</p>
1	<p>Intercom system for patient and radiographer communication The ASK-4® 501-TLI-CF is a single zone audio monitoring system with 2-way talk/listen capabilities. It consists of a remote speaker/microphone and audio base station with built-in microphone and speaker.</p>
1	<p>Medical Gases SF6 for Installation and Service Includes:</p> <ul style="list-style-type: none"> • Cylinder • Regulator • Delivery
1	<p>Medical Gases Nitrogen for Installation and Service Includes:</p> <ul style="list-style-type: none"> • Cylinder • Regulator • Delivery
2	<p>Elekta Linear Accelerator Physics Objective After completing this course, attendees will:</p> <ul style="list-style-type: none"> • Identify different components of an Elekta linear accelerator. • Operate the linear accelerator's controls. • Summarize the system communication and the different protocols used. • Operate the accelerator in service and clinical modes. • Perform calibration of dosimetry system. • Understand fundamentals of MLC control system, optical tracking, and calibration. • Outline the operation of imaging systems for IGRT and perform basic quality assurance. <p>Course Content</p> <ul style="list-style-type: none"> • Theory of Operation • Control Sytem and System Communication • Beam Measurement and Dosimetry • Agility Beam Limiting Device • Imaging Systems and Introduction to IGRT <p>The application has been made to CAMPEP for 31.2 Medical Physics Continuing Education Credits (MPCEC.)</p> <p>Duration 5-day training at Elekta's Region North America LINC</p> <p>Target Group</p> <ul style="list-style-type: none"> • Medical Physicists • Medical Physics Students <p>Pre-requisites None</p>

Qty	Description
2	<p>Medical Accelerator Quality Assurance After completing this course, attendees will:</p> <ul style="list-style-type: none"> List all AAPM TASK GROUP 142 REPORT report tests and their recommended frequency. Perform Dosimetry, mechanical, safety, respiratory gating, universal wedge, MLC, and imaging tests and evaluate results of these tests. Evaluate all AAPM TG 142 report tests and determine applicability of each test to their clinical setting. Analyze potential causes of test failures in order to assist in determining necessary corrective actions in conjunction with Elekta and/or Field System Engineer. List Elekta linear accelerator characteristics and how they apply to TASK GROUP 142 REPORT accelerator QA. <p>Course Content</p> <ul style="list-style-type: none"> During this course, participants will learn about the philosophy and purpose of the recommendations given in the AAPM TASK GROUP 142 REPORT report: Quality assurance of medical accelerators. The recommended tests listed in the AAPM TASK GROUP 142 REPORT report will be presented and evaluated during this course in order for medical physicist to understand the clinical rational of each test, evaluate the necessity of each test for their specific clinical setting, and how to execute the tests in their clinical setting. The application has been made to CAMPEP for Medical Physics Continuing Education Credits (MPCEC). <p>Duration 3-day training at Elekta's Region North America LINC</p> <p>Target Group Certified Medical Physicists Medical Physics Students</p> <p>Pre-requisites Physics 1 : Medical Accelerator Introduction</p>
2	<p>Volumetric Modulated Arc Therapy (VMAT) QA Objectives After completing this course, attendees will:</p> <ul style="list-style-type: none"> Explain the clinical rational for the VMAT treatment technique. Evaluate the key factors influencing the quality of VMAT plans. List advantages and limitations of VMAT treatment technique. Explain the method by which VMAT is delivered by an Elekta linear accelerator. List the constraints required by the delivery system to ensure optimal treatment planning. Evaluate which aspects of VMAT must be tested prior to clinical use. Perform Picket Fence with Gantry Rotation, synchronization of dose rate and gantry speed, and synchronization of dose rate and MLC speed tests to evaluate proper performance of the Elekta medical accelerator. Develop and execute commissioning benchmark tests to determine baseline system performance for routine quality control testing post future repairs, upgrades, or cal checks. Discuss implementation strategies for patient specific measurement to determine gamma pass rate of the delivered plan. <p>Content During this one-day course, attendees will learn the rationale for VMAT as a treatment technique and the different methods for creating VMAT treatment plans. The course will also cover VMAT delivery, commissioning, and quality assurance for the Elekta medical accelerator as well as advantages and limitations for VMAT as a treatment technique. The application has been made to CAMPEP for 7.75 Medical Physics Continuing Education Credits (MPCEC).</p> <p>Duration 1 day</p> <p>Target Audience</p> <ul style="list-style-type: none"> Certified Medical Physicists Medical physics students <p>Prerequisites</p> <ul style="list-style-type: none"> Physics 1: Medical Accelerator Introduction Quality Assurance of Elekta Medical Accelerators.
1	<p>A Frame for Installation/Service Includes:</p> <ul style="list-style-type: none"> A Frame Trolley Hoist (pulley) <p>Delivery Note: Not required if iBeam is in place.</p>

Qty	Description
1	480VAC INPUT TRANSFORMER ONLY SYSTEM
1	Software Media Kit, Integrity 4.0.5
1	MRT 29661 SHFR400 KV GENERATOR MAINS FILTER ASSEMBLY
1	Control system CCP
1	Pre-install cable kits
1	<p>Elekta Linac Onsite Applications Training/Support Onsite applications training follow up and/or applications support for the Elekta Linac. An Elekta Applications Specialist will review Elekta Linac workflows with staff, give workflow recommendations, and help address any problem areas. Target Audience: Maximum of 6 users: Radiation Therapists, Medical Physicists, Radiation Oncologist Duration: 2 days Location: Customer site</p>
2	<p>Elekta Stereotactic Radiosurgery and Stereotactic Body Radiotherapy Physics Course During this 4-day course, participants will learn the physics behind the operation of an Elekta Medical Accelerator with Agility MLC, APEX MLC, and Stereotactic Cones. Students will build on the principles of operation of the accelerator as addressed in Elekta Medical Accelerator Physics 1 and the quality assurance aspects taught in Elekta Machine QA. Students will learn about the principles of each of the systems in regards to their Commissioning, Quality Assurance and Application for SRS and SBRT. Objectives After completing this course, attendees will:</p> <ul style="list-style-type: none"> • Be able to accept, commission and QA the SRS/SBRT solution • Perform small field dosimetry • Perform commissioning measurements • Describe the relationship of various isocenters in the accelerator • Perform Winston Lutz tests • Explain patient immobilization options • Describe IGRT options for patient positioning verification • Explain appropriate routine QA tests • Perform End to End testing • Understand requirements of AAPM TG54, TG 101 and ASTRO Target Safety reports <p>Target Audience</p> <ul style="list-style-type: none"> • Certified Medical Physicists • Medical Physics students <p>Prerequisites</p> <ul style="list-style-type: none"> • Physics 1: Medical Accelerator Introduction <p>Pricing Includes</p> <ul style="list-style-type: none"> • Tuition for one student <p>Pricing Does Not Include</p> <ul style="list-style-type: none"> • Airfare • Hotel • Travel-related expenses <p>Your eligibility for this course expires:</p> <ul style="list-style-type: none"> • Purchased with new equipment - twenty-four (24) months after Acceptance or first clinical use, whichever occurs first. • Purchased directly - 24 months after Purchase Order is accepted.
1	MONACO MASTER BEAM MODELS
1	Linac removal & destruction by 3rd party.

Qty	Description
1	<p>Elekta Linear Accelerator Physics Training This course will cover the Theory of Operation, Control System and System Communication, Beam Measurement and Dosimetry, Agility Beam Limiting Device, Imaging Systems and Introduction to IGRT on the Medical Accelerator.</p>
1	<p>Medical Accelerator Quality Assurance Training During this course, participants will learn about the philosophy and purpose of the recommendations given in the AAPM TASK GROUP 142 REPORT report: Quality assurance of medical accelerators.</p>
1	<p>Volumetric Arc Therapy Quality Assurance Training During this course, attendees will learn the rationale for VMAT as a treatment technique and the different methods for creating VMAT treatment plans. The course will also cover VMAT delivery, commissioning, and quality assurance for the Elekta medical accelerator as well as advantages and limitations for VMAT as a treatment technique.</p>
1	<p>iViewGT Linac Specific Activation License – DOSIsoft This license is required to enable connectivity with iViewGT and is licensed per iViewGT workstation.</p>
1	<p>In Room Optical Kit</p>
1	<p>XVI Advanced Imaging Symmetry Training (Online) This course is delivered 100% online as a virtual instructor led training. Users will learn how to create XVI Symmetry presets, prepare reference images for Symmetry, acquire Symmetry scans, and register Symmetry scans. This will be an interactive hands-on course that utilizes an Elekta XVI training database for practice exercises. Users will also have access to additional clinical educational content from Elekta Clinical Partners. Target Audience: Radiation Therapists, Medical Physicists, Radiation Oncologist Duration: Online virtual instructor led training sessions will be delivered as 2, 1 hour sessions. Location: Online</p>
1	<p>HexaPOD evo - Universal Camera Mount - Kit The Universal Camera Mount is part of the HexaPOD evo RT System and will be shipped from the service warehouses. The independent shipment from the warehouses enables a pre-installation of the UCM if required.</p>

CONNECTIVITY, MONITORING AND REMOTE ACCESS DURING WARRANTY

For Linac:

In order to provide the warranty for the Products, the Customer agrees to provide dedicated high-speed broadband internet connections suitable to establish a remote connection to the necessary components including but not limited to Linac and associated components and facilitate the realization of the required remote infrastructure, as agreed by the Parties.

If the Customer fails to provide the access described in this section and so the solution is not connected to Elekta IntelliMax[®] or equivalent Elekta approved solution (including any temporary disconnection), the Customer waives its rights to receive services and any uptime guarantees.

IntelliMax Agent software is installed on a standalone workstation or virtual machine. The IntelliMax Agent communicates with applicable products and acts as a gateway to the IntelliMax Enterprise (outbound via the internet). More than one IntelliMax Agent may be required for full connectivity. For more information see Elekta IntelliMax[®] Security Information, available from your Elekta representative.

Should remote access to the desktop of the device be reasonably necessary, IntelliMax Connect allows for either attended (mandatory for treatment machines) or unattended access (configurable during installation for software systems). Access via

Elekta IntelliMax[®], and details of any files transferred are recorded in an audit log which is available on upon request for a period of 12 months after the transfer.

The Customer acknowledges and agrees that notwithstanding the provisions contained in Customer's Elekta Purchase and License Agreement, Elekta shall have the ability to remotely monitor Elekta supplied systems on the Customers network via Elekta IntelliMax[®] to gain information and aid in diagnosis and correction of system issues. Remote Access/screen sharing, is configurable separately and can be set to only allow visibility of the customer's screens when initiated by the customer.